

TASCAM

D01136920G

CD-500/500B

CD Player

OWNER'S MANUAL

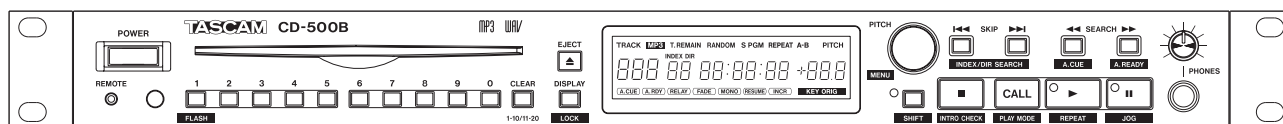
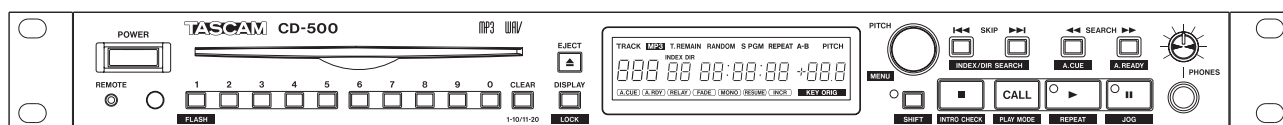

IMPORTANT SAFETY INSTRUCTIONS



CAUTION
RISK OF ELECTRIC SHOCK
DO NOT OPEN



CAUTION: TO REDUCE THE RISK OF ELECTRIC SHOCK, DO NOT REMOVE COVER (OR BACK). NO USER-SERVICEABLE PARTS INSIDE. REFER SERVICING TO QUALIFIED SERVICE PERSONNEL.



The lightning flash with arrowhead symbol, within equilateral triangle, is intended to alert the user to the presence of uninsulated "dangerous voltage" within the product's enclosure that may be of sufficient magnitude to constitute a risk of electric shock to persons.



The exclamation point within an equilateral triangle is intended to alert the user to the presence of important operating and maintenance (servicing) instructions in the literature accompanying the appliance.

WARNING: TO PREVENT FIRE OR SHOCK HAZARD, DO NOT EXPOSE THIS APPLIANCE TO RAIN OR MOISTURE.

- 1 Read these instructions.
- 2 Keep these instructions.
- 3 Heed all warnings.
- 4 Follow all instructions.
- 5 Do not use this apparatus near water.
- 6 Clean only with dry cloth.
- 7 Do not block any ventilation openings. Install in accordance with the manufacturer's instructions.
- 8 Do not install near any heat sources such as radiators, heat registers, stoves, or other apparatus (including amplifiers) that produce heat.
- 9 Do not defeat the safety purpose of the polarized or grounding-type plug. A polarized plug has two blades with one wider than the other. A grounding type plug has two blades and a third grounding prong. The wide blade or the third prong are provided for your safety. If the provided plug does not fit into your outlet, consult an electrician for replacement of the obsolete outlet.
- 10 Protect the power cord from being walked on or pinched particularly at plugs, convenience receptacles, and the point where they exit from the apparatus.
- 11 Only use attachments/accessories specified by the manufacturer.

- 12 Use only with the cart, stand, tripod, bracket, or table specified by the manufacturer, or sold with the apparatus. When a cart is used, use caution when moving the cart/apparatus combination to avoid injury from tip-over.



- 13 Unplug this apparatus during lightning storms or when unused for long periods of time.
 - 14 Refer all servicing to qualified service personnel. Servicing is required when the apparatus has been damaged in any way, such as power-supply cord or plug is damaged, liquid has been spilled or objects have fallen into the apparatus, the apparatus has been exposed to rain or moisture, does not operate normally, or has been dropped.
- Do not expose this apparatus to drips or splashes.
 - Do not place any objects filled with liquids, such as vases, on the apparatus.
 - Do not install this apparatus in a confined space such as a book case or similar unit.
 - The apparatus draws nominal non-operating power from the AC outlet with its POWER or STANDBY/ON switch not in the ON position.
 - The apparatus should be located close enough to the AC outlet so that you can easily grasp the power cord plug at any time.
 - The mains plug is used as the disconnect device, the disconnect device shall remain readily operable.
 - Products with Class I construction are equipped with a power supply cord that has a grounding plug. The cord of such a product must be plugged into an AC outlet that has a protective grounding connection.
 - If the product uses batteries (including a battery pack or installed batteries), they should not be exposed to sunshine, fire or excessive heat.
 - CAUTION for products that use replaceable lithium batteries: there is danger of explosion if a battery is replaced with an incorrect type of battery. Replace only with the same or equivalent type.
 - Caution should be taken when using earphones or headphones with the product because excessive sound pressure (volume) from earphones or headphones can cause hearing loss.

In North America use only on 120V supply.

■ RACK-MOUNTING THE UNIT

Use the supplied rack-mounting kit to mount the unit in a standard 19-inch rack, as shown below.

Remove the feet of the unit before mounting.

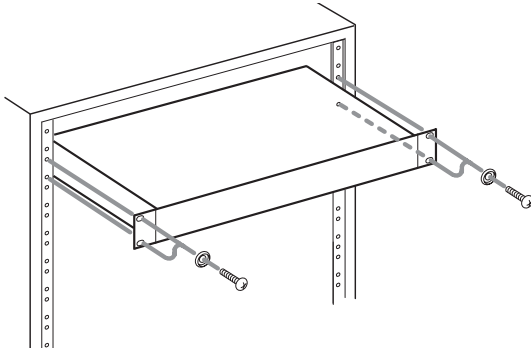

NOTE

- Leave 1U of space above the unit for ventilation.
- Allow at least 10 cm (4 in) at the rear of the unit for ventilation.

■ For U.S.A.

TO THE USER

This equipment has been tested and found to comply with the limits for a Class A digital device, pursuant to Part 15 of the FCC Rules. These limits are designed to provide reasonable protection against harmful interference when the equipment is operated in a commercial environment. This equipment generates, uses, and can radiate radio frequency energy and, if not installed and used in accordance with the instruction manual, may cause harmful interference to radio communications.

Operation of this equipment in a residential area is likely to cause harmful interference in which case the user will be required to correct the interference at his own expense.

CAUTION

Changes or modifications to this equipment not expressly approved by TEAC CORPORATION for compliance could void the user's authority to operate this equipment.

■ For European Customers

CE Marking Information

- a) Applicable electromagnetic environment: E4
- b) Peak inrush current: 11 A

Disposal of electrical and electronic equipment

- (a) All electrical and electronic equipment should be disposed of separately from the municipal waste stream via collection facilities designated by the government or local authorities.
- (b) By disposing of electrical and electronic equipment correctly, you will help save valuable resources and prevent any potential negative effects on human health and the environment.

- (c) Improper disposal of waste electrical and electronic equipment can have serious effects on the environment and human health because of the presence of hazardous substances in the equipment.
- (d) The Waste Electrical and Electronic Equipment (WEEE) symbol, which shows a wheeled bin that has been crossed out, indicates that electrical and electronic equipment must be collected and disposed of separately from household waste.



- (e) Return and collection systems are available to end users. For more detailed information about the disposal of old electrical and electronic equipment, please contact your city office, waste disposal service or the shop where you purchased the equipment.

Disposal of batteries and/or accumulators

- (a) Waste batteries and/or accumulators should be disposed of separately from the municipal waste stream via collection facilities designated by the government or local authorities.
- (b) By disposing of waste batteries and/or accumulators correctly, you will help save valuable resources and prevent any potential negative effects on human health and the environment.
- (c) Improper disposal of waste batteries and/or accumulators can have serious effects on the environment and human health because of the presence of hazardous substances in them.
- (d) The WEEE symbol, which shows a wheeled bin that has been crossed out, indicates that batteries and/or accumulators must be collected and disposed of separately from household waste.



If a battery or accumulator contains more than the specified values of lead (Pb), mercury (Hg), and/or cadmium (Cd) as defined in the Battery Directive (2006/66/EC), then the chemical symbols for those elements will be indicated beneath the WEEE symbol.

- (e) Return and collection systems are available to end users. For more detailed information about the disposal of waste batteries and/or accumulators, please contact your city office, waste disposal service or the shop where you purchased them.

WARNING

This is a Class A product. In a domestic environment, this product may cause radio interference in which case the user may be required to take adequate measures.

Safety Information

CAUTIONS ABOUT BATTERIES

This product uses batteries. Misuse of batteries could cause a leak, rupture or other trouble. Always abide by the following precautions when using batteries.

- Never recharge non-rechargeable batteries. The batteries could rupture or leak, causing fire or injury.
- When installing batteries, pay attention to the polarity indications (plus/minus (+/-) orientation), and install them correctly in the battery compartment as indicated. Putting them in backward could make the batteries rupture or leak, causing fire, injury or stains around them.
- When you store or dispose batteries, isolate their terminals with insulation tape or something like that to prevent them from contacting other batteries or metallic objects.
- When throwing used batteries away, follow the disposal instructions indicated on the batteries and the local disposal laws.
- Do not use batteries other than those specified. Do not mix and use new and old batteries or different types of batteries together. The batteries could rupture or leak, causing fire, injury or stains around them.
- Do not carry or store batteries together with small metal objects. The batteries could short, causing leak, rupture or other trouble.
- Do not heat or disassemble batteries. Do not put them in fire or water. Batteries could rupture or leak, causing fire, injury or stains around them.
- If the battery fluid leaks, wipe away any fluid on the battery case before inserting new batteries. If the battery fluid gets in an eye, it could cause loss of eyesight. If fluid does enter an eye, wash it out thoroughly with clean water without rubbing the eye and then consult a doctor immediately. If the fluid gets on a person's body or clothing, it could cause skin injuries or burns. If this should happen, wash it off with clean water and then consult a doctor immediately.
- The unit power should be off when you install and replace batteries.
- Remove the batteries if you do not plan to use the unit for a long time. Batteries could rupture or leak, causing fire, injury or stains around them. If the battery fluid leaks, wipe away any fluid on the battery compartment before inserting new batteries.
- Do not disassemble a battery. The acid inside the battery could harm skin or clothing.

CAUTIONS ABOUT LASER RADIATION

This product has been designed and manufactured according to FDA regulations "title 21, CFR, chapter 1, subchapter J, based on the Radiation Control for Health and Safety Act of 1968," and is classified as a class 1 laser product. There is no hazardous invisible laser radiation during operation because invisible laser radiation emitted inside of this product is completely confined in the protective housings.

The label required in this regulation is shown at ①.

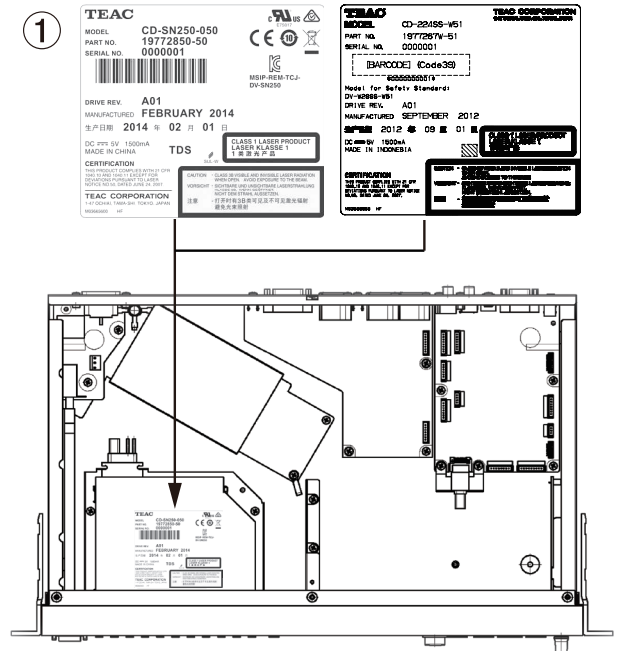

Cautions:

- DO NOT REMOVE THE PROTECTIVE HOUSING USING A SCREWDRIVER.
- USE OF CONTROLS OR ADJUSTMENTS OR PERFORMANCE OF PROCEDURES OTHER THAN THOSE SPECIFIED HEREIN MAY RESULT IN HAZARDOUS RADIATION EXPOSURE.
- IF THIS PRODUCT DEVELOPS TROUBLE, CONTACT YOUR NEAREST QUALIFIED SERVICE PERSONNEL, AND DO NOT USE THE PRODUCT IN ITS DAMAGED STATE.

Optical pickup

Type:	LO-DWU01
Manufacturer:	Lite-Space Technology Co., Ltd.
Laser output:	Less than 93.1 mW on the objective lens (CD) Less than 90.3 mW on the objective lens (DVD)
Wavelength:	785 nm (CD) typ. 661 nm (DVD) typ.
Standard:	IEC60825-1: 2007

Optical pickup

Type:	SW 653L VP
Manufacturer:	Hitachi Media Electronics Co.,Ltd
Laser output:	Less than 120mW on the objective lens (DVD) Less than 95mW on the objective lens (CD)
Wavelength:	661 nm (Typ) (DVD) 785 nm (Typ) (CD)
Standard:	IEC60825-1 : 2007

1 – Introduction	7		
Differences between the CD-500 and CD-500B models	7		
Features	7		
Included items	8		
About this manual	8		
Trademarks.....	8		
Precautions for placement and use.....	8		
Connecting the power	8		
Beware of condensation.....	8		
Cleaning the unit.....	9		
About discs.....	9		
Handling of compact discs	9		
Slot loading of discs	9		
2 – Names and Functions of Parts	10		
Front panel	10		
Rear panel	12		
Display.....	13		
Wireless remote control (TASCAM RC-500)	14		
3 – Preparation.....	16		
Making connections	16		
Preparing the remote control	17		
Inserting batteries.....	17		
When to replace the batteries.....	17		
Precautions about using batteries.....	17		
Precautions about using the remote control... ..	17		
Remote control reception settings.....	17		
Panel lock function	18		
4 – Menu	19		
Menu structure	19		
Menu operation basics	19		
5 – Operation	20		
Compatible disc and file types	20		
Directories and tracks on data CDs	20		
Loading discs	21		
Inserting a disc	21		
Ejecting a disc.....	21		
Eject block function	21		
Playing back a CD.....	21		
Selecting a track	22		
Skipping to the next or previous track.....	22		
Designating track numbers.....	22		
Selecting indexes and directories	22		
Using the SEARCH buttons.....	23		
Using the jog function to search.....	23		
Playback modes.....	23		
Selecting the playback mode	23		
6 – Various Playback Functions	24		
Auto-cue function	24		
Setting the auto-cue level	24		
Auto-ready function	24		
Resume function	24		
Call function	25		
Incremental play function	25		
Repeat playback	25		
Ordinary repeat playback	25		
A-B repeat playback	25		
Intro check mode	26		
Power on play function.....	26		
Pitch control playback.....	26		
Setting the pitch adjustment increment.....	27		
Changing the playback speed without changing the pitch (KEY ORIG)	27		
Program playback	27		
Program setting mode.....	27		
Checking the program	28		
Editing the program.....	28		
Fade in/fade out playback	28		
Skip back playback	29		
Setting the skip back time	29		
Flash start function	29		
Relay playback	30		
7 – Other Functions	31		
Changing the playback time display mode.....	31		
Frame time display setting	31		
End of track warning (EOM).....	31		
Interval time setting	31		
Outputting in mono	32		
Controlling the player with a foot switch	32		
Setting the foot switch	32		
Using the foot switch.....	32		
Foot switch mode settings.....	32		
Fader and event start	32		
Fader start and stop	32		
Event start	33		
Using the RS-232C connector	33		
Setting the baud rate	33		
Restoring factory default settings	33		
Checking the firmware version.....	33		
User data settings (CD-500B only)	34		
Using the parallel control (CD-500B only).....	34		
8 – Troubleshooting	35		

Contents

9 – Error Messages	36
10 – Specifications	37
Media and formats	37
Analog audio output	37
Digital audio output	37
Control input and output	37
Audio performance	37
Backup memory	37
General	38
Dimensional drawings	38

产品有毒有害物质或元素的名称及含量

机种：CD-500/CD-500B		有毒有害物质或元素					
	品名	铅 (Pb)	汞 (Hg)	镉 (Cd)	六价铬 (Cr(VI))	多溴联苯 (PBB)	多溴二苯醚 (PBDE)
1	CHASSIS部份	○	○	○	○	○	○
2	PCB Assy部份	×	○	○	○	○	○
3	线材部份	○	○	○	○	○	○
4	附属品部份	×	○	○	○	○	○
7	SEAL部份	○	○	○	○	○	○
8	包装部份	○	○	○	○	○	○

○：表示该有毒有害物质在该部件所有均质材料中的含量均在 SJ/T11363-2006 标准规定的限量要求以下。
×：表示该有毒有害物质至少在该部件的某一均质材料中的含量超出 SJ/T11363-2006 标准规定的限量要求。
(针对现在代替技术困难的电子部品及合金中的铅)

Thank you very much for purchasing the TASCAM CD-500/500B CD Player.

Before connecting and using the unit, please take time to read this manual thoroughly to ensure you understand how to properly set up and connect the unit, as well as the operation of its many useful and convenient functions. After you have finished reading this manual, please keep it in a safe place for future reference.

You can also download the Owner's Manual from the TEAC Global Site (<http://teac-global.com/>).

Differences between the CD-500 and CD-500B models

The CD-500 is the standard model and the CD-500B is a model with additional professional features. These additional features include XLR balanced analog output connectors, an AES/EBU digital output connector (XLR) and a parallel external control connector.

Features

- 10-second anti-shock memory prevents skipping caused by vibrations, for example
- Dedicated knob for $\pm 16\%$ pitch control
- Plays ordinary audio CDs, CD-R and CD-RW discs, including files in both MP3 and WAV formats
- Cueing with one-frame precision
- Support for fader start and event start control
- Parallel control connector on CD-500B model
- When using the parallel connector (CD-500B only), the transport mode, including fader start and event start, as well as flash start and direct start modes can be set
- RS-232C serial connector can be used to connect a computer or external controller to control the unit
- Program memory can store information for up to 100 discs
- Incremental play function
- Auto-ready function can automatically pause playback after track completes playing at the beginning of the next track
- Auto-cue function can ready the unit to start playback of a track from the moment sound starts
- Transport and pitch can be controlled using a TASCAM RC-3F footswitch (sold separately)
- Flash start function enables playback without delay (tracks 1–20 or the first 20 tracks in the program)
- Number buttons on the front panel can be used for track selection and the flash start function
- Skip back function can go back a few seconds (amount can be set) during playback
- TASCAM RC-500 wireless remote control included (can be disabled using a setting on the main unit)
- Gap between tracks during playback can be set
- Balanced output level can be set by making an internal adjustment (CD-500B only; requires servicing by TASCAM technical support)
- Panel buttons can be locked to prevent misoperation
- Eject block function can be used to prevent discs from being ejected during playback or when paused
- Slot loading of discs
- RCA unbalanced outputs
- Coaxial digital output (S/PDIF)
- Optical digital output (S/PDIF)
- XLR balanced outputs (CD-500B only)
- XLR AES/EBU digital output (CD-500B only)
- Monophonic output possible
- Playback modes include all tracks (ALL), one track (SINGLE), program (up to 100 tracks) and random
- Repeat modes include all tracks (ALL), one track (SINGLE), tracks in the program and looping of an A-B interval
- Display can be set to show track elapsed time, track remaining time or disc remaining time
- CALL function can be used to return to the last point where playback started
- Intro check function
- Fade in and fade out can be set from 0 to 10 seconds in 0.5-second intervals
- Automatic playback when power turned on possible
- Relay playback of multiple units possible
- Index search (audio CD (CD-DA) only) and directory search (MP3 or WAV file discs only) functions
- Resume function remembers the last point when playback stopped
- Support for EOM display showing the end of a track
- Headphones jack and level knob on the front panel for monitoring

1 – Introduction

Included items

The included items are listed below.

Take care when opening the package not to damage the items. Keep the package materials for transportation in the future.

Please contact the store where you purchased this unit if any of these items are missing or have been damaged during transportation.

- Main unit 1
- Power cord 1
- Wireless remote control (TASCAM RC-500) 1
- AAA batteries for the remote control unit..... 2
- A rack-mounting screw kit..... 1
- Owner's manual (this manual) 1

The warranty is included at the end of this manual.

NOTE

The batteries are not supplied for Taiwan.

About this manual

In this manual, we use the following conventions:

- Unless otherwise specified, references to the "CD-500" also indicate CD-500B players.
- The names of buttons and controls are given in the following typeface: **SHIFT**.
- Messages on the unit's display are shown like this: **ON**
- The CD-DA format may also be mentioned as "audio CD" format.
- CDs on which MP3 or WAV audio files are recorded may be mentioned as "data CDs".
- Additional information is introduced in the styles below when needed:

TIP

Useful hints when using the unit.

NOTE

Explanation of actions in special situation and supplement.

CAUTION

Instructions that should be followed to avoid injury, damage to the unit or other equipment, and loss of data.

Trademarks

- TASCAM is a trademark of TEAC Corporation, registered in the U.S. and other countries.
- MPEG Layer-3 audio coding technology licensed from Fraunhofer IIS and Thomson.
- Other company names, product names and logos in this document are the trademarks or registered trademarks of their respective owners.

Precautions for placement and use

- The operating temperature should be between 5°C and 40°C (41°F and 104°F).
- Do not install in the following types of places. Doing so could degrade the sound quality and/or cause malfunctions.
 - Places with significant vibrations or that are otherwise unstable
 - Near windows or other places exposed to direct sunlight
 - Near heaters or other extremely hot places
 - Extremely cold places
 - Places with bad ventilation or high humidity
 - Very dusty locations
- This unit can be installed at an angle of $\pm 30^\circ$.
- Do not place any object on the unit for heat dissipation.
- Avoid installing this unit on top of any heat-generating electrical device such as a power amplifier.

Connecting the power

- Insert the included power cord into the **AC IN** connector completely.
- Hold the power cord by the plug when connecting or disconnecting it.

Beware of condensation

If the unit is moved from a cold to a warm place, or used immediately after a cold room has been heated or otherwise exposed to a sudden temperature change, condensation could occur. Should this happen, leave the unit for one or two hours before turning the unit on.

Cleaning the unit

To clean the unit, wipe it gently with a soft dry cloth. Do not wipe with chemical cleaning cloths, benzene, paint thinner, ethyl alcohol or other chemical agents to clean the unit as they could damage the surface.

About discs

In addition to commercially-available music CDs, this unit can play CD-R and CD-RW discs that have been recorded in audio CD (CD-DA) format, as well as CD-R and CD-RW discs that have MP3 audio and WAV audio files recorded on them.

NOTE

8-cm CDs cannot be used with this unit. If you insert an 8-cm CD, the unit will eject it automatically. If it does not eject far enough to remove, press the **EJECT** button.

Handling of compact discs

- Always insert the compact discs in the slot with their label facing upward.
- To remove a disc from its case, press down on the center of the disc holder, then lift the disc out, holding it carefully by the edges.
- Do not touch the signal side (the unlabeled side). Fingerprints, oils and other substances can cause errors during playback.
- To clean the signal side of a disc, wipe gently with a soft dry cloth from the center towards the outside edge. Dirt on discs can lower the sound quality, so clean them and always store them in a clean state.
- Do not use any record spray, anti-static solutions, benzene, paint thinner or other chemical agents to clean CDs as they could damage the delicate playing surface. It may cause CDs to become unplayable.
- Do not apply labels or other materials to discs. Do not use discs that have had tape, stickers or other materials applied to their surface. Do not use discs that have sticky residue from stickers, etc. Such discs could become stuck in the unit or cause it to malfunction.
- Never use a commercially available CD stabilizer. Using stabilizers with this player will damage the mechanism and cause it to malfunction.
- Do not use cracked discs.
- Only use circular compact discs. Avoid using non-circular promotional, etc. discs.



- Music discs with copy control, a copy-protection system, have been released from several record companies in an attempt to protect the copyright. Since some of these discs do not comply with the CD specifications, they may not be playable on the unit.

Slot loading of discs

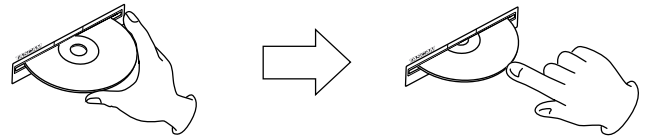

- 1 As shown in the illustration, hold the disc with the labeled side up and insert it part way into the slot.**
- 2 After you push the disc a little further, it will be pulled in automatically just before it disappears into the slot.**

Trouble inserting a disc

If the disc becomes stuck during insertion, for example, and is difficult to push, do not try to force the disc in. Pull the disc out once and press the eject button and then try inserting it again. (Trying to force the disc in could damage the unit.)

2 – Names and Functions of Parts

Front panel

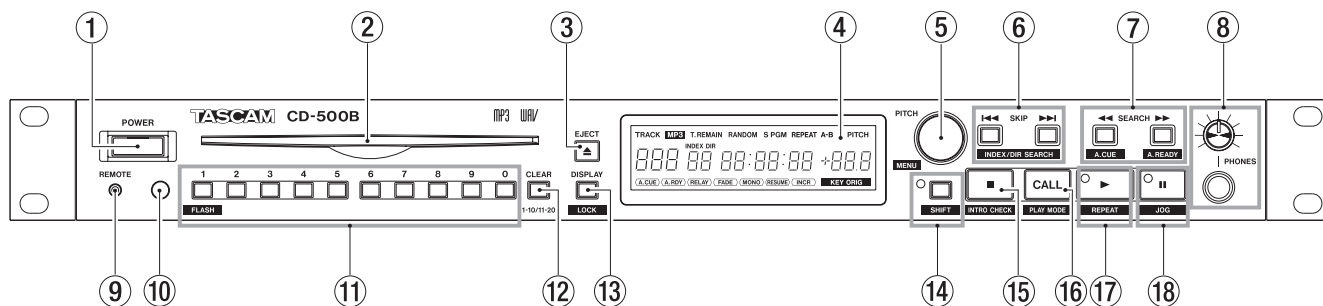

① POWER switch

Press to turn the power on and off.

CAUTION

Before turning the power on, minimize the volume of other equipment that is connected to this unit. Failure to do so might cause sudden loud noises, which could harm your hearing or result in other trouble.

② Disc slot

After inserting a disc partway, it will automatically be pulled in.

③ EJECT button

Press to eject a disc.

④ Display

Shows various types of information.

⑤ PITCH [MENU] knob

This is a multifunction knob that works as both a dial and a button. Use this knob to set the pitch control value, use menus, set the A-B repeat interval and as a jog dial, for example.

Press this knob to turn the pitch control function on and off. When it is on, turn this knob to adjust the pitch. (See "Pitch control playback" on page 26.)

When in shift mode (when the **SHIFT** indicator is lit), press this knob to open the menu.

When in menu mode, turn this knob to select items and press it to confirm a selection. (See "Menu operation basics" on page 19.)

When in jog mode, use this knob as a jog dial to search one frame at a time. (See "Using the jog function to search" on page 22.)

When using the A-B repeat function, press this knob to set the A and B points. (See "A-B repeat playback" on page 25.)

⑥ SKIP ◀◀/▶▶ [INDEX/DIR SEARCH] buttons

Use these buttons for track selection (skipping).

When in shift mode (when the **SHIFT** indicator is lit), use these to select indexes. When a data CD is loaded however, use these to make directory selections instead.

Set the auto-cue function to determine what happens after selection. (See "Skipping to the next or previous track" on page 21.)

In program setting mode, use these to select tracks for the program.

⑦ SEARCH ◀◀/▶▶ [A.CUE/A.READY] buttons

During playback or when paused, press the ◀◀ button to search backward, and press the ▶▶ button to search forward. (See "Using the SEARCH buttons" on page 22.)

When in program setting mode, use these to select the program number. (See "Program playback" on page 27.)

When in shift mode (when the **SHIFT** indicator is lit), press the ◀◀ button to turn the auto-cue function on and off. (See "Auto-cue function" on page 24.)

When in shift mode (when the **SHIFT** indicator is lit), press the ▶▶ button to turn the auto-ready function on and off. (See "Auto-ready function" on page 24.)

⑧ PHONES jack/knob

Connect stereo headphones to this standard stereo phone jack. Use the **PHONES** knob to adjust the headphones output level.

CAUTION

Before connecting headphones, turn the **PHONES** knob to minimize the volume. Failure to do so might cause sudden loud noises, which could harm your hearing or result in other trouble.

⑨ REMOTE jack (2.5-mm TRS)

Use this jack to connect a TASCAM RC-3F foot switch (sold separately). Use this remote control to start and stop playback and other operations.

⑩ Remote control receiver

This receives signals from the included TASCAM RC-500 wireless remote control. Point the end of the remote control toward here when using it.

⑪ Number buttons

Use these number buttons to designate track numbers to select songs. Input two digits for audio CDs and three digits for data CDs. (See "Designating track numbers" on page 22.)

2 – Names and Functions of Parts

When in shift mode (when the **SHIFT** indicator is lit), press the **1 [FLASH]** button to turn the flash start function on and off.

⑫ **CLEAR [1-10/11-20] button**

Press this button to cancel the input of a number button.

Press and hold when the program menu is open to clear the program.

Press this button to switch between track and flash start program numbers 1-10 and 11-20.

⑬ **DISPLAY [LOCK] button**

Press this button when the playback time is shown to switch the playback time display mode (track elapsed time, track remaining time or total remaining time). (See “Changing the playback time display mode” on page 31.)

When in menu mode, press this button to exit menu mode.

When in shift mode (when the **SHIFT** indicator is lit), press and hold this button to turn the panel lock function on and off. This function prevents the use of the buttons to avoid misoperation.

When not in shift mode (when the **SHIFT** indicator is not lit), press and hold this button to turn index display on/off (with audio CDs only).

⑭ **SHIFT button and indicator**

Press this button to activate shift mode. When the shift mode is active, the indicator lights and the shift functions of other buttons are enabled. (Shift functions are shown below buttons with white lettering on a dark blue background.)

Press the **SHIFT** button again to deactivate the shift mode. (The **SHIFT** indicator is not lit when deactivated.)

Press this button when in menu mode to exit menu mode.

⑮ **■ (stop) [INTRO CHECK] button**

Press to stop playback.

If the incremental playback function is activated, press this button during playback to pause at the beginning of the next track.

When stopped, activate shift mode (**SHIFT** indicator lit), and press this button to activate the intro check mode. When this mode is activated, press the **▶ (play) [REPEAT]** button to play the first 10 seconds of each track in succession. (See “Intro check mode” on page 26.)

NOTE

Even when shift mode is active (**SHIFT** indicator lit), pressing this button during playback will stop playback.

⑯ **CALL [PLAY MODE] button**

Press this button to return to the point where playback was last started and pause.

When in shift mode (when the **SHIFT** indicator is lit), press this button to switch the playback mode

(ordinary, single, program or random). (See “Playback modes” on page 23.)

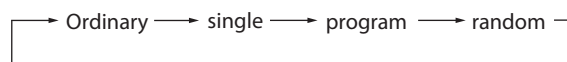

⑰ **▶ (play) [REPEAT] button and indicator**

When stopped, press this button to start playback. (The indicator lights during playback.)

When paused, press this button to resume playback.

During playback, press this button to return to the point that was previously set. (See “Skip back playback” on page 29.)

When in shift mode (when the **SHIFT** indicator is lit), press this button to turn the repeat playback function on or off. (See “Ordinary repeat playback” on page 25.)

When in shift mode (when the **SHIFT** indicator is lit), press and hold this button for more than a second during playback or when paused to turn the A-B repeat function on. (See “A-B repeat playback” on page 25.)

⑱ **II (pause) [JOG] button and indicator**

Press during playback to pause (indicator lights).

When the auto-cue function is on, press when stopped to pause at the instant when sound begins in track 1. When the auto-cue function is off, press when stopped to pause at the beginning of track 1.

When in shift mode (when the **SHIFT** indicator is lit), pause the unit to enable jog mode. (Alternatively, activate shift mode when already paused.) (See “Using the jog function to search” on page 22.)

2 – Names and Functions of Parts

Rear panel

CD-500 rear panel

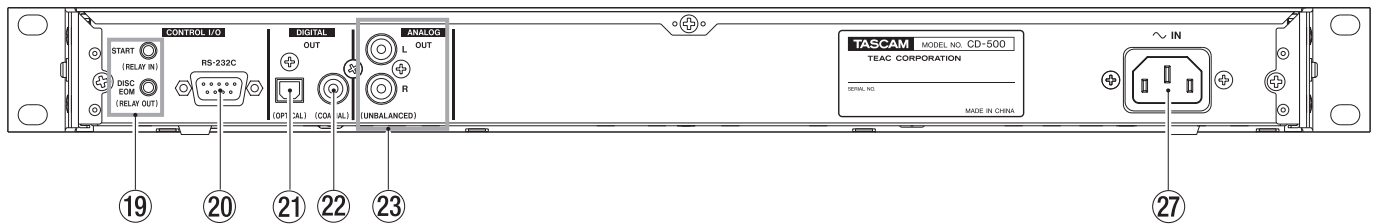

CD-500B rear panel

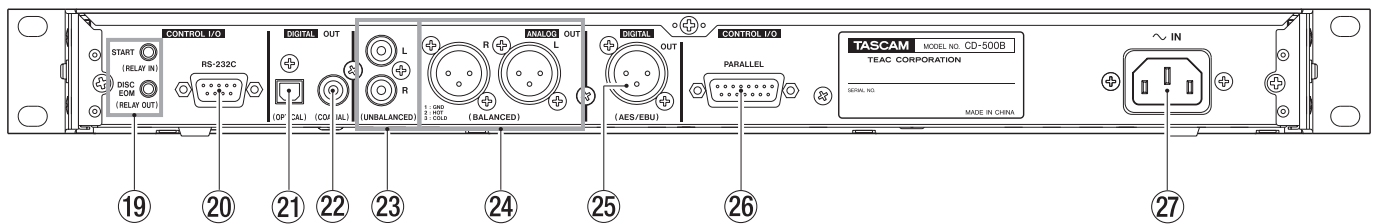

19 CONTROL I/O START (RELAY IN) and DISC EOM (RELAY OUT) jacks (3.5-mm mini-jacks)

Use these jacks for fader start and event start, as well as for relay playback of multiple CD-500 and CD-500B units. (See “Relay playback” on page 30 and “Fader and event start” on page 32.)

20 CONTROL I/O RS-232C connector

This is a D-sub 9-pin RS-232C serial control connector. Connect an external controller, for example, here. (See “Using the RS-232C connector” on page 33.)

21 DIGITAL OUT (OPTICAL) connector

The digital CD playback signal is output in S/PDIF format.

22 DIGITAL OUT (COAXIAL) connector

The digital CD playback signal is output in S/PDIF format.

NOTE

- When playing back MP3 or WAV files, the sampling frequency of this unit’s digital outputs is 44.1 kHz.
- When using the pitch control function while playing an audio CD or another disc with MP3 or WAV files, the digital output is at a fixed sampling frequency of 44.1 kHz.

23 ANALOG OUT (UNBALANCED) jacks

These are analog outputs for the CD playback signal. The maximum output level is +6 dBV.

24 ANALOG OUT (BALANCED) connectors (CD-500B only)

These are balanced analog outputs for the CD playback signal. The maximum output level is +20 dBu. (1: GND, 2: HOT, 3: COLD)

25 DIGITAL OUT (AES/EBU) connector (CD-500B only)

This is a balanced digital audio XLR connector that outputs AES3-2003/IEC 60958-4 (AES/EBU) format.

NOTE

If the signal is not output from this connector correctly, confirm that the “22 U-DATA” menu item is set to “OFF”. (See “User data settings” on page 34.)

26 CONTROL I/O PARALLEL connector (CD-500B only)

This is a D-sub 15-pin parallel control connector. Use this to connect an external controller, for example. (See “Fader start and stop” on page 32 and “Using parallel control” on page 34.)

27 AC IN connector

Connect the included power cord here.

Display

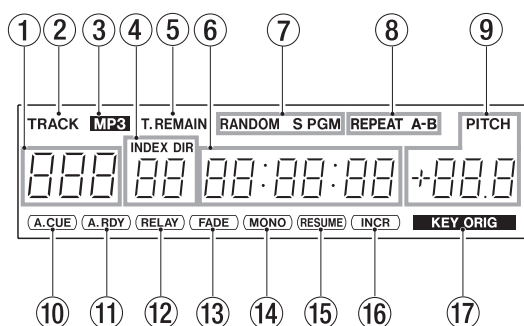

① Track number

This shows the track number during playback and track selection.

When an audio CD is loaded, a two-digit track number is shown. When a data CD is loaded, a three-digit track number is shown.

When in menu mode, the menu number is shown here.

② TRACK indicator

This appears when a disc that has files that this unit can play back is loaded.

③ MP3 indicator

This appears when an MP3 disc is loaded.

④ INDEX DIR number

During playback and selection, the index number (audio CD) or directory number (data CD) is shown here.

When not in shift mode (when the **SHIFT** indicator is not lit), press and hold the **DISPLAY [LOCK]** button to turn index number display on/off.

⑤ Playback time display mode indicator

When the time display is showing the playback time, the following appears depending on the display mode. (See "Changing the playback time display mode" on page 31.)

- When the playback time display mode is set to remaining time, **T.REMAIN** appears.
- When the playback time display mode is set to track remaining time, **REMAIN** appears.
- When the playback time display mode is set to track elapsed time, nothing appears here. Likewise, nothing appears when in menu mode or program setting mode.

⑥ Time display

This shows the time of the current playback position.

When in menu mode, the menu item is shown. When menu items are shown, the letters appear as follows.

ABCDEFGHIJKLM NOPQRSTUVWXYZcginor
 ABCDEFGHIJL PNOPPQR STUVW 4Y2c9inor

⑦ Playback mode indicators

The current playback mode is shown.

- Ordinary (all tracks) playback mode: Nothing appears
- Single playback mode: **S** appears
- Program playback mode: **PGM** appears
- Random playback mode: **RANDOM** appears

⑧ Repeat mode indicators

The repeat mode is shown. (See "Repeat playback" on page 25 and "A-B repeat playback" on page 25.)

- Repeat mode: **REPEAT** appears
- A-B repeat mode: **REPEAT** and **A-B** appear (Before the A and B points have been set, the indicator shown here will vary depending on the status. For details, see "A-B repeat playback" on page 25.)

⑨ PITCH indicator (and pitch adjustment)

When the pitch control function is ON, **PITCH** appears, and the amount of speed change is shown. (See "Pitch control playback" on page 26.)

When in menu mode, the setting value of the menu item is shown.

⑩ A.CUE (auto-cue) indicator

When the auto-cue function is on, **A.CUE** appears. (See "Auto-cue function" on page 24.)

⑪ A.RDY (auto-ready) indicator

When the auto-ready function is on, **A.RDY** appears. (See "Auto-ready function" on page 24.)

⑫ RELAY (relay playback) indicator

When the relay playback function is on, **RELAY** appears. (See "Relay playback" on page 30.)

⑬ FADE indicator

When the fade in/out function is on, **FADE** appears. (See "Fade in/fade out playback" on page 28.)

⑭ MONO indicator

When the mono output function is on, **MONO** appears. (See "Outputting in mono" on page 32.)

⑮ RESUME indicator

When the resume function is on, **RESUME** appears. (See "Resume function" on page 24.)

⑯ INCR indicator (incremental play)

When the incremental play function is on, **INCR** appears. (See "Incremental play function" on page 25.)

⑰ KEY ORIG (original key) indicator

When the original key function is on, **KEY ORIG** appears. (See "Changing the playback speed without changing the pitch (KEY ORIG)" on page 27.)

2 – Names and Functions of Parts

Wireless remote control (TASCAM RC-500)

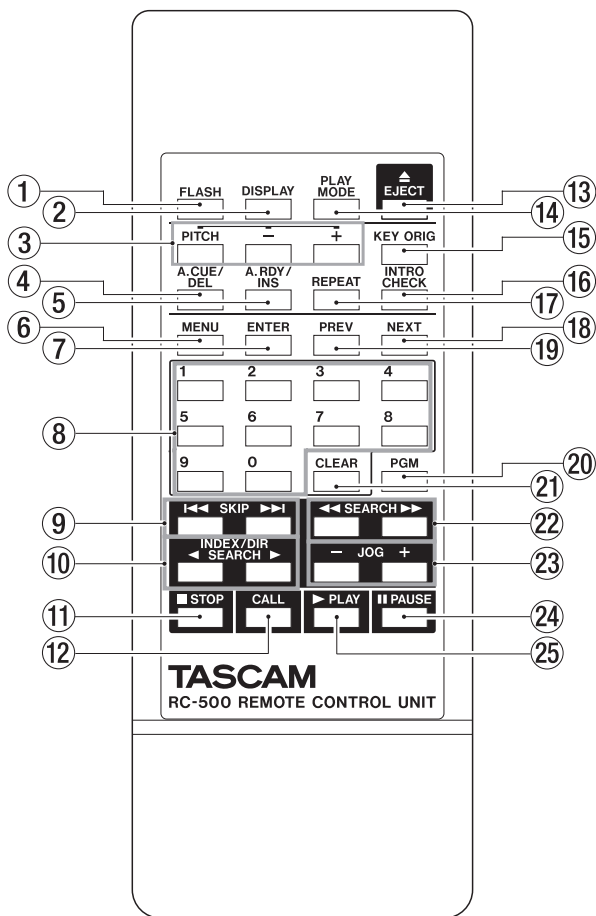

① FLASH button

Press to turn the flash start function on and off.

② DISPLAY button

Press this button to change the playback time display mode shown (track elapsed time, track remaining time or remaining time). (See "Changing the playback time display mode" on page 31.)

When in menu mode, press this button to exit menu mode.

When not in shift mode (when the **SHIFT** indicator is not lit), press and hold this button to turn index display on/off (with audio CDs only).

③ PITCH and -/+ buttons

Press the **PITCH** button to turn the pitch control function on and off. Use the - and + buttons to set the pitch control value. (See "Pitch control playback" on page 26.)

④ A.CUE/DEL button

Press this to turn the auto-cue function on and off. (See "Auto-cue function" on page 24.)

Use this also to delete program tracks. (See "Program playback" on page 27.)

⑤ A.RDY/INS button

Press this to turn the auto-ready function on and off. (See "Auto-ready function" on page 24.)

Use this also to add program tracks. (See "Program playback" on page 27.)

⑥ MENU button

Press this button to enter menu mode. When in menu mode, press this button to exit menu mode. (See "Menu operation basics" on page 19.)

⑦ ENTER button

When in menu mode, press to confirm a menu item selection or setting value. (See "Menu operation basics" on page 19.)

When using the A-B repeat function, press this to set the A and B points. (See "A-B repeat playback" on page 25.)

⑧ Number buttons

Use these number buttons to designate track numbers to select songs. Input two digits for audio CDs and three digits for data CDs. (See "Designating track numbers" on page 22.)

⑨ SKIP (I<</>>I) buttons

Use these buttons for track selection (skipping).

Set the auto-cue function to determine what happens after selection. (See "Skipping to the next or previous track" on page 21.)

In program setting mode, use these to select tracks for the program. (See "Program playback" on page 27.)

⑩ INDEX/DIR SEARCH (◀/▶) buttons

Use these to select indexes on an audio CD or directories on a data CD. Set the auto-cue function to determine what happens after selection. (See "Selecting indexes and directories" on page 22.)

⑪ STOP button

Press to stop playback. If the incremental play function is activated, press this button during playback to pause at the beginning of the next track. (See "Incremental play function" on page 25.)

⑫ CALL button

During playback or when paused, press this button to return to the point where playback was last started and pause. (See "Call function" on page 25.)

⑬ EJECT button

Press this to eject a disc.

⑭ PLAY MODE button

Press this button to cycle through the playback modes. Choose from ordinary, single, program and random.

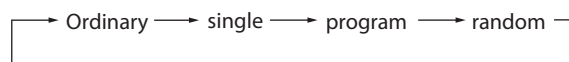

⑮ KEY ORIG button

Turn the original key function, which changes the speed without changing the pitch, on and off. (See "Changing the playback speed without changing the pitch (KEY ORIG)" on page 27.)

16 **INTRO CHECK button**

When stopped, during playback or when paused, press this button to activate intro check mode. When in intro check mode, press the ► **PLAY** button to play the first 10 seconds of each track in succession. (See “Intro check mode” on page 26.)

17 **REPEAT button**

Press to turn the repeat playback function on and off. (See “Repeat playback” on page 25.)

Press and hold for more than one second to turn the A-B repeat function on. (See “A-B repeat playback” on page 25.)

18 **NEXT button**

When in menu mode, press to select the next value (menu item or setting value). (See “Menu operation basics” on page 19.)

19 **PREV button**

When in menu mode, press to select the previous value (menu item or setting value). (See “Menu operation basics” on page 19.)

20 **PGM button**

Press to open program setting mode. (See “Program playback” on page 27.)

21 **CLEAR button**

Press this button to cancel the input of a number button.

Press and hold when the program menu is open to clear the program.

22 **SEARCH (◀◀/▶▶) buttons**

During playback or when paused, press the ◀◀ button to search backward, and press the ▶▶ button to search forward. (See “Using the SEARCH buttons” on page 22.)

When in program setting mode, use these to select the program number. (See “Program playback” on page 27.)

23 **JOG (-/+) buttons**

When paused, press a **JOG** (+ or –) button to enter jog mode. Press the + button to advance one frame, and press the – button to go back one frame. (See “Using the jog function to search” on page 22.)

24 **II PAUSE button**

Press during playback to pause.

When the auto-cue function is on, press when stopped to pause at the instant when sound begins in track 1.

When the auto-cue function is off, press when stopped to pause at the beginning of track 1.

25 **► PLAY button**

When stopped, press this button to start playback.

When paused, press this button to resume playback.

When the incremental play function is on, press this button during playback to start playback of the next track. When the incremental play function is off, press this button during playback to use skip back playback.

3 – Preparation

Making connections

The illustration below shows an example of connecting other equipment with a CD-500B.

Precautions before making connections

- Before connecting other devices to the unit, read their manuals carefully.
- Turn off the power (or put power into standby mode) for this unit and all equipment that will be connected to it.
- Connect all the devices to the same power supply line. When using a power strip, for example, use a thick cable with a high current capacity to minimize variation in the power voltage.

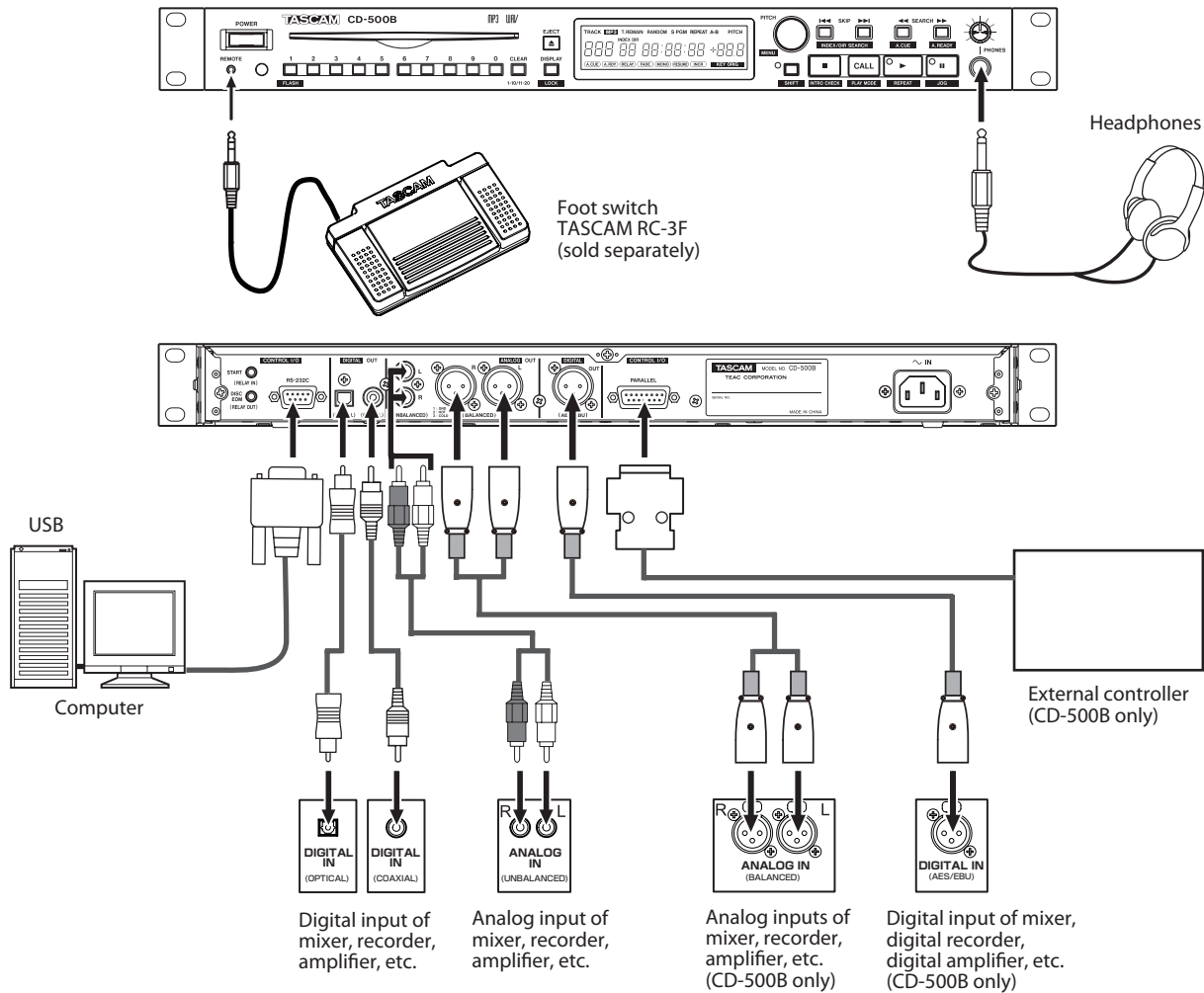

Connecting a foot switch

Connect a TASCAM RC-3F foot switch (sold separately) to the **REMOTE** connector to enable it to control some unit operations. (See “Controlling the player with a foot switch” on page 32.)

Connecting headphones

Connect stereo headphones to the **PHONES** jack on the front panel. Use the **PHONES** knob to adjust the volume.

CAUTION

Before connecting headphones, turn the **PHONES** knob to minimize the volume. Failure to do so might cause sudden loud noises, which could harm your hearing or result in other trouble.

Connecting with a computer

Connect the **RS-232C** connector on this unit to a RS-232C connector on a computer to allow serial control of this unit from that computer.

After connecting the unit to a computer, make transmission settings correctly on this unit. (See “Using the RS-232C connector” on page 33.)

Connecting digital audio equipment

Connect the digital inputs of stereo amplifiers, mixers, recorders and other digital equipment to this unit’s digital output connectors.

Connecting analog audio equipment

Connect the analog inputs of stereo amplifiers, mixers, recorders and other analog equipment to this unit's analog output connectors.

NOTE

Cables are not included with this unit

Using parallel control (CD-500B only)

To use an external controller for parallel control of the CD-500B, use the **CONTROL I/O PARALLEL** connector (D-Sub 15-pin). For the pin assignments of the PARALLEL connector, see "Using the parallel connector [CD-500B only]" on page 32.

Preparing the remote control

Inserting batteries

- 1 Open the cover on the back of the remote control.

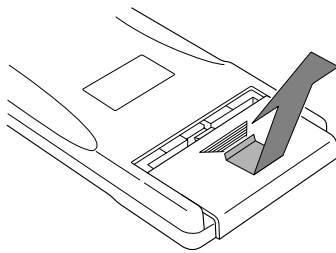

- 2 Insert two AAA batteries with the correct ± orientations.

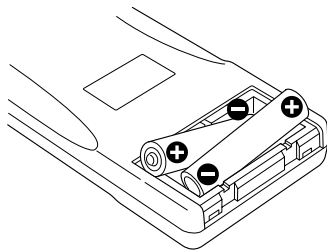

- 3 Close the cover.

NOTE

The batteries are not supplied for Taiwan.

When to replace the batteries

Replace both batteries with new ones when the range of the remote control becomes short or if the buttons become unresponsive.

Precautions about using batteries

Misuse of batteries could cause them to leak, rupture or otherwise be damaged. Please read and abide by the precautions on the battery labels when using them. See page 4 of this manual for additional precautions.

Precautions about using the remote control

- When using other devices controlled by infrared rays, use of this remote control might operate these devices by mistake.
- Use the remote control within the following range.

Remote sensor

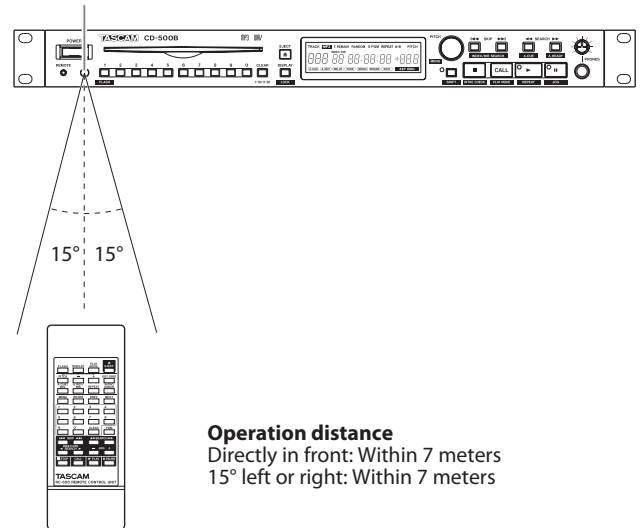

Operation distance

Directly in front: Within 7 meters
15° left or right: Within 7 meters

Remote control reception settings

Operation of the unit using the remote control can be disabled in order to prevent misoperation.

Use the 15 IR menu item to set whether or not the unit can be operated by remote control (default value: ON).

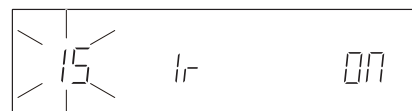

NOTE

- If remote control reception has been set to OFF, IR OFF will appear on the display when any of the remote control buttons are pushed.
- The remote control reception setting (on/off) is saved even if the unit's power is turned off.

3 – Preparation

Panel lock function

When in shift mode (when the **SHIFT** indicator is lit), press and hold the **DISPLAY [LOCK]** button to turn the panel lock function on or off. When it is on, all the buttons on the front panel of the unit (except the **SHIFT** and **DISPLAY [LOCK]** buttons) and the remote control are disabled. **LOCKED** will appear on the display if you push any of the buttons.

NOTE

- Even when the panel lock function is enabled, the unit can be controlled by a TASCAM RC-3F foot switch connected to the **REMOTE** jack on the front panel and external controllers connected to the **RS-232C** connector and **CONTROL I/O PARALLEL** connectors on the rear panel.
- The panel lock setting (on/off) is saved even if the unit power is turned off.

Use the unit's menu system to make various settings. Among the menu setting items are some that can also be set using dedicated buttons on the remote control.

Menu structure

The menu structure of the unit includes the following items.

Menu number	Item	Function set	Reference
01	Origin	Original key	Page 27
02	EJECT	Eject block	Page 21
03	A-CUE	Auto-cue level	Page 24
04	Prog	Program	Page 27
05	FADE	Fade in/out playback	Page 29
06	RELAY	Relay playback	Page 30
07	P onPL	Power on play	Page 26
08	Mono	Mono output	Page 32
09	RESUM	Resume	Page 24
10	EOM	EOM (TRACK EOM) time display	Page 31
11	Inc-P	Incremental play	Page 25
12	P-STEP	Pitch control steps	Page 27
13	232C	Baud rate	Page 33
14	S-BAC	Skip back	Page 29
15	IR	Remote control reception	Page 17
16	INTVAL	Silent interval between tracks	Page 31
17	FRAM	Frame time display	Page 31
18	REMOT	Foot switch mode	Page 32
19	FLASH	Flash start	Page 29
20	RESET	Restore unit to factory defaults	Page 33
21	INFO	View the firmware version	Page 33
22	U-DATA	User data settings (AES/EBU, CD-500B only)	Page 34
23	PARALL	Set the parallel function (CD-500B only)	Page 34

Menu operation basics

The basic procedures for making settings using the menu system are as follows.

- When the display shows the usual playback information, activate the menu mode in which you can select menu items by using the unit's front panel buttons or the included TASCAM RC-500 remote control.**
 - When using the front panel buttons:** In shift mode (when the **SHIFT** indicator is lit), press the **PITCH [MENU]** knob.
 - When using the remote control:** Press the **MENU** button.

The center area of the display shows the menu item selected. The menu item that was selected the last time that the unit was in menu mode appears.

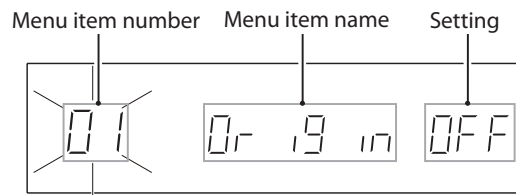

- Use the unit's front panel buttons or the remote control to conduct the following operation to select the desired menu item.**

- When using the front panel buttons:** Turn the **PITCH [MENU]** knob or use the number buttons to select the menu item, and press the **PITCH [MENU]** knob to confirm.
- When using the remote control:** Use the **PREV** and **NEXT** buttons, as well as the number buttons to select the menu item, and press the **ENTER** button to confirm.

NOTE

- The menu item number blinks before it has been confirmed.
- When using the number buttons input two digits to select menu items. For example, to select menu number 06, press the **0** button followed by the **6** button.

The following step (3) applies to all items except 04 PROG, 19 FLASH, 20 RESET and 21 INFO. See their explanations for instructions about how to use these items.

- Select the desired value.**

- When using the front panel buttons:** Turn the **PITCH [MENU]** knob to select the value and press the **PITCH [MENU]** knob to confirm the setting.
- When using the remote control:** Use the **PREV** and **NEXT** buttons to select the value and press the **ENTER** button to confirm the setting.

NOTE

- When a value different from the active setting is selected, the value blinks. After the new setting is confirmed, menu mode ends and the display shows the usual playback information again.
- To quit menu mode without changing a setting, press the **SHIFT** button or **DISPLAY [LOCK]** button on the front panel of the unit, or press the **MENU** button on the remote control.

5 – Operation

Compatible disc and file types

This unit can play the following types of discs and files.

CD-DA format discs (audio CDs)

This unit can play commercially-available music CDs and CD-R and CD-RW discs that have been recorded in audio CD format. These types of discs are called “audio CDs” in this manual.

This unit cannot play unfinalized CD-R or CD-RW discs.

CD-ROM format discs (data CDs)

This unit can play discs that have MP3 and WAV files and use ISO 9660 Level 1, Level 2 or Joliet file system formats. These types of discs are called “data CDs” in this manual.

NOTE

- This unit can play back MP3 files that have sampling frequencies of 32, 44.1 and 48 kHz and have bit-rates of 32–320 kbps or are variable bit-rate (VBR).
- This unit can play back WAV files that have sampling frequencies of 32 kHz/44.1 kHz/48 kHz and are 16-bit.

CAUTION

- When playing back MP3 or WAV files, the sampling frequency of this unit’s digital outputs is 44.1 kHz. When the pitch control function is enabled, output is also digital, and some devices might not be able to receive digital output from this unit.
- This unit uses the “.mp3” file extension to recognize MP3 files. Always add the “.mp3” extension to MP3 file names. The player cannot play back MP3 files that do not have the “.mp3” extension. In addition to having the “.mp3” extension, the file must also be in the proper MP3 data format to allow playback by this unit.
- This unit uses the “.wav” file extension to recognize WAV files. Always add the “.wav” extension to WAV file names. The player cannot play back WAV files that do not have the “.wav” extension. In addition to having the “.wav” extension, the file must also be in the proper WAV data format to allow playback by this unit.
- Discs that contain more than 1000 files or 255 directories might not play back correctly.
- Depending on the condition of a disc, this unit might not be able to play it back, or skipping might occur.

Directories and tracks on data CDs

This unit treats all the audio (WAV and MP3) files on data CDs as “tracks.” Some data CDs store files inside directories (folders) in the same way that ordinary computers do. In addition, directories can be stored inside other directories creating a multilevel structure.

This unit assigns a directory number to each directory to manage them. Directory numbers are assigned sequentially starting with the directories at the highest level followed by the directories (subfolders) inside them. If the root directory of a data CD contains one or more audio files, it will be numbered as the first directory.

Each audio file is also assigned a track number. Track numbers are assigned in order starting from those in the lowest numbered directory.

During ordinary playback of data CDs, tracks are played back in the assigned numerical order just like those on an audio CD.

Directories that do not directly contain audio files are not given numbers. For example, in the illustration below the directory that contains Directory 5 is not given a number.

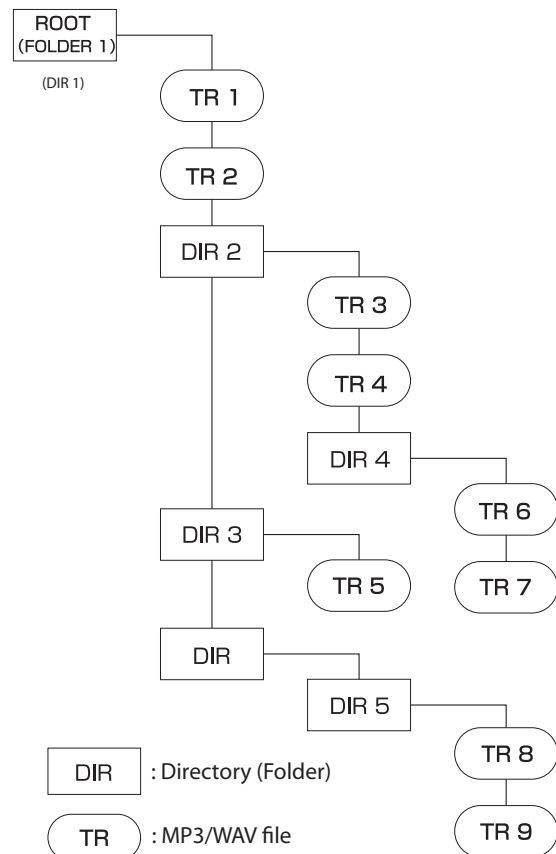

An example of data CD structure

Loading discs

Inserting a disc

Hold the disc with its label side up and insert it part way into the disc slot. Push the disc in a little further and, just before it disappears, it should automatically be pulled into the player. After a disc is loaded, the player will read its information. If it is an audio CD, the display will show the total number of tracks and total playback time. If it is a data CD, the display will show the total number of tracks in the current directory.

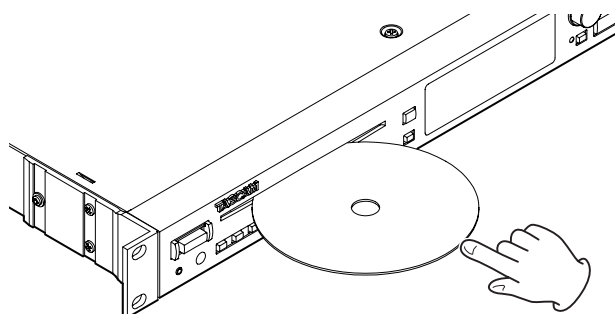

CAUTION

- You cannot load a disc when the power is off.
- In order to prevent the accidental insertion of a disc when another disc is already loaded, this unit is equipped with a "disc stopper". (After a disc is loaded, the stopper in the insertion slot rises.)
When inserting a disc, pulling it out when it is partially inserted or forcing it in with excessive strength, for example, could scratch the disc or damage the unit.
- If the disc becomes caught or is otherwise difficult to push, do not force it in. Press the **EJECT** button and remove the disc once before trying to reinsert it. Forcing the disc into the player could damage the disc or even break the player.
- If a disc other than an audio CD is inserted or a disc is inserted upside down, it will automatically be ejected.
- 8-cm CDs cannot be used with this unit. If an 8-cm CD is inserted, it will automatically be ejected. If it is not automatically ejected completely, press the **EJECT** button.

Ejecting a disc

Press the **EJECT** button on the player or the remote to eject the disc part way. Pull the disc out the rest of the way by its edges.

CAUTION

The **EJECT** buttons on the player and the remote do not function when the player's power is off.

Eject block function

The eject block function allows you to disable the operation of the **EJECT** buttons on the player and the remote during playback and when paused in order to prevent playback from being interrupted accidentally by the pressing one of these buttons.

To turn the eject block function on, set the 02 EJECT menu item to BL.



NOTE

The eject block function on/off setting is maintained even when the player's power is turned off.

Playing back a CD

The following procedures assume that the necessary connections have been completed, the player's power has been turned on and a CD (audio or data) has been loaded.

To start playback, press the ► **(play) [REPEAT]** button on the player or the ► **PLAY** button on the remote.

Stopping playback

Press the ■ **(stop) [INTRO CHECK]** button on the player or the ■ **STOP** button on the remote.

Pausing playback

Press the || **(pause) [JOG]** button on the player or the || **PAUSE** button on the remote.

To restart playback, press the ► **(play) [REPEAT]** button on the player or the ► **PLAY** button on the remote.

NOTE

In this manual, unless stated otherwise, explanations assume that continuous playback mode is enabled. (See "Playback modes" on page 23.)

5 – Operation

Selecting a track

You can move (skip) to the previous or next track, or you can select a track directly by its track number.

Skipping to the next or previous track

Press the **SKIP** **I◀◀ / ▶▶I** [**INDEX/DIR SEARCH**] button on the player or the **SKIP** **I◀◀ / ▶▶I** button on the remote to select a track. What happens after you use **SKIP** buttons to select a track depends on whether the auto-cue function is on or off. (See “Auto-cue function” on page 24.)

When stopped

If the auto-cue function is off, playback starts after the track is selected.

If the auto-cue function is on, playback pauses at the instant when sound begins in the track. To start playback after this, press the **▶ (play) [REPEAT]** button on the player or the **▶ PLAY** button on the remote.

During playback

The selected track will start playing back.

When paused

If the auto-cue function is off, playback pauses at the beginning of the selected track.

If the auto-cue function is on, playback pauses at the instant when sound begins in the track.

NOTE

If you press the **I◀◀** button once during playback or when paused, playback will skip to the beginning of the current track. However, if playback is one second or less from the beginning of the current track, pressing the **I◀◀** button will skip to the previous track.

Designating track numbers

Use the number buttons on the player or the remote to directly designate track numbers.

■ With audio CDs

Enter two digits. For example, if the track number is “9”, enter “0” followed by “9”.

■ With data CDs

Enter three digits. For example, if the track number is “105”, enter “1”, “0” and then “5”. If the track number is “4”, enter “0”, “0” and then “4”.

When stopped, use the number buttons to designate a track number and,

- If the auto-cue function is off, start playback of that track.
- If the auto-cue function is on, pause playback at the instant when sound begins in that track.

During playback, use the number buttons to designate a track number and start playback of that track.

When paused, use the number buttons to designate a track number and,

- If the auto-cue function is off, pause playback at the beginning of that track.
- If the auto-cue function is on, pause playback at the instant when sound begins in that track.

Selecting indexes and directories

You can select track indexes on audio CDs and directories on data CDs.

NOTE

- Audio CD indexes are divisions within tracks. In other words, they are units that are smaller than tracks.
- Data CD directories are folders that contain MP3 and WAV files (tracks). In other words, they are units that are larger than tracks.

Use the following procedures to select indexes and directories.

Using the front panel buttons:

When in shift mode (**SHIFT** indicator lit) use the **SKIP** **I◀◀ / ▶▶I** [**INDEX/DIR SEARCH**] buttons to select them.

Using the remote control:

Use the **INDEX/DIR SEARCH** **◀/▶** buttons to select them.

When a data CD directory is selected, the first track inside that directory will automatically start playing back (unless the auto-cue function is on, in which case it will pause at the instant when sound first begins in the first track).

When an audio CD index is selected, playback of the track from the selected index will begin (unless the auto-cue function is on, in which case it will pause at the instant sound first begins in the designated index).

Using the SEARCH buttons

You can search forward and backward in a track while listening to it.

- 1 **Play or pause the desired track.**
- 2 **Press and hold a SEARCH ◀◀/▶▶ [A.CUE/A.READY] button on the player or a SEARCH ◀◀/▶▶ button on the remote to start searching forward or backward.**
- 3 **Release the button that you are holding to stop searching and return the player to the state it was in before searching (playback or pause).**

NOTE

The search function cannot be used with data CDs.

Using the jog function to search

You can use the jog function to search a track one frame at a time. However, this function cannot be used with data CDs.

Using the front panel buttons:

When paused and in shift mode (**SHIFT** indicator lit), turn the **PITCH [MENU]** knob to enter jog mode, and search the track one frame at a time.

Using the remote control:

When paused, press a **JOG (+/-)** button to enter jog mode. Press the **+** button to advance one frame, and press the **-** button to go back one frame.

NOTE

In jog mode, if you stop searching, playback will pause, but the sound at the current position will be output continuously.

Playback modes

This unit has 4 playback modes.

The current playback mode is indicated on the display.

■ Continuous playback mode (default setting)

Nothing appears in the playback mode indication area at the top of the display.

The tracks on the disc are played back in numerical order.

■ Single playback mode

◻ appears in the playback mode indication area at the top of the display.

The selected track is played back once and then playback stops.

■ Program playback mode

PGM appears in the playback mode indication area at the top of the display.

Tracks are played back in the order programmed in advance. (See “Program playback” on page 27.)

■ Random playback mode

RANDOM appears in the playback mode indication area at the top of the display.

Tracks on the disc are played back in random order.

Selecting the playback mode

Use the following procedures to set the desired playback mode using the controls on the player or the included TASCAM RC-500 remote control.

Using the front panel buttons:

When in shift mode (**SHIFT** indicator lit), press the **CALL [PLAY MODE]** button to cycle through the playback modes.

Using the remote control:

Press the **PLAY MODE** button to cycle through the playback modes.

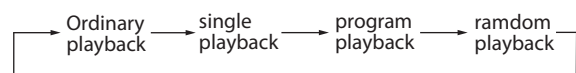

NOTE

Playback mode settings are retained even when the power is turned off.

6 – Various Playback Functions

This chapter explains the various playback functions of the unit.

Auto-cue function

If the auto-cue function is on and you select a track to play, any silence at the beginning of the track will be skipped, and the player will pause at the instant when a sound signal is first detected. This means that sound can be heard immediately when playback starts.

NOTE

- When the flash start function is used for playback, the auto-cue function is disabled.
- If the auto-cue function is on and a track is selected during playback, that track will play back from the instant that sound begins in the selected track. If the auto-cue function is on and a track is selected when paused, the player will pause at the instant that sound begins in the selected track.

Moreover, you can set the audio signal detection threshold level (auto-cue level) that is used by the auto-cue function. Any signal higher than the set auto cue level will be recognized as “sound,” and any signal lower than this level will be treated as “silence.”

The following procedure describes how to use the menu to turn the auto-cue function on/off and adjust the auto-cue level setting. (For details about using the menu screen, refer to the “Menu operation basics” on page 19.)

■ Turning the auto-cue function on/off

Using the front panel buttons:

When in shift mode (**SHIFT** indicator lit), press the **SEARCH ◀◀ [A.CUE]** button to turn it on/off.

Using the remote control:

Press the **A.CUE/DEL** button to turn it on/off.

When the auto-cue function is on, **A.CUE** appears in the lower part of the display.

NOTE

The auto-cue function on/off setting is retained even when the power is turned off.

Setting the auto-cue level

To set the auto-cue function trigger level (auto-cue level), use the **03 A-CUE** menu item.



Options: 24 (default value), 30, 36, 42, 48, 54, 60, 66, 72

These values represent auto-cue levels in dB. The point when the signal level of the selected track first exceeds the auto-cue level is recognized as the instant when sound starts.

NOTE

The auto-cue level setting is retained even when the power is turned off.

Auto-ready function

If the auto-ready function is on, after a track has finished playing, playback will pause at the beginning of the next track.

NOTE

- If the auto-cue function is also on, playback will pause at the instant when sound starts rather than at the beginning of the track.
- When using the flash start function for playback, the auto-ready function is disabled.

■ Turning the auto-ready function on/off

Using the front panel buttons:

When in shift mode (**SHIFT** indicator lit), press the **SEARCH ▶▶** button to turn it on/off.

Using the remote control:

Press the **A.RDY/INS** button to turn it on/off.

When the auto-ready function is on, **A.RDY** appears in the lower part of the display.

NOTE

The auto-ready function on/off setting is retained even when the power is turned off.

Resume function

When the resume function is on, the position where playback stops is memorized. When playback is started again playback resumes from that position. When this function is used with a data CD, however, playback resumes from the beginning of the track that was playing when playback was stopped.

To turn the resume function on/off, use the **09 RESUM** menu item (default value: OFF).

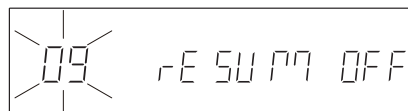

When the resume function is on, **RESUME** appears in the lower part of the display.

NOTE

The resume function on/off setting is retained even when the power is turned off.

Call function

During playback or when paused, press the **CALL [PLAY MODE]** button on the player or the **CALL** button on the remote to locate to the point when playback last started and pause playback. However, when this function is used with a data CD, playback pauses at the beginning of the track that was playing when playback was last started.

Incremental play function

When the incremental play function is on, pressing the **▶ PLAY** button on the remote during playback will start playback from the beginning of the next track, and pressing the **■ (stop) [INTRO CHECK]** button on the player or the **■ STOP** button on the remote will pause playback at the beginning of the next track.

NOTE

- When the incremental play function is on and playback is paused, pressing the **▶ PLAY** button on the remote will start playback from that point, and pressing the **■ (stop) [INTRO CHECK]** button on the player or the **■ STOP** button on the remote stops playback.
- During playback of the last track, if you press the **▶ PLAY** button on the remote, playback of the first track will start. If you press the **■ (stop) [INTRO CHECK]** button on the player or the **■ STOP** button on the remote, playback will pause at the beginning of the first track.
- Setting the CD-500B control I/O parallel connector pin 13 (PLAY) to ON has the same effect.
- Receiving a stop command from the CD-500B control I/O parallel connector pin 11 (FADER START/STOP) has the same effect.

To turn the incremental play function on/off, use the **11 Inc-P** menu item (default value: OFF).

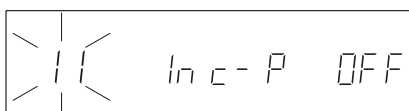

When the incremental play function is on, **INCR** appears in the lower part of the display.

NOTE

The incremental play function on/off setting is retained even when the power is turned off.

Repeat playback

You can repeatedly play back all tracks or repeatedly play back a specified region within a track (A-B repeat playback).

Ordinary repeat playback

When the repeat playback function is on, behavior depends on the playback mode.

- All track playback (ordinary playback) mode: the entire disc is played back repeatedly
- Single track playback mode: the current track is played back repeatedly
- Program playback mode: all the tracks in the program are played back repeatedly
- Random playback mode: all the tracks on the disc are played back at random repeatedly

Use one of the following procedures to turn the repeat playback function on.

Using the front panel buttons:

When in shift mode (**SHIFT** indicator lit), press the **▶ [REPEAT]** button. **REPEAT** appears at the top of the display when repeat mode is activated.

Using the remote control:

Press the remote **REPEAT** button. **REPEAT** appears at the top of the display when repeat mode is activated.

Use one of the following procedures to turn the repeat playback function off.

- When the player is in shift mode (**SHIFT** indicator lit), press the **▶ [REPEAT]** button again until **REPEAT** disappears from the top of the screen.
- Press the **REPEAT** button on the remote until **REPEAT** disappears from the top of the screen.

NOTE

The repeat playback setting is retained even when the power is turned off.

A-B repeat playback

You can specify a desired interval (A-B) within a track to be played back repeatedly. Use the following procedures to enable A-B repeat playback.

- 1 **During playback or when paused, when the player is in shift mode (SHIFT indicator lit), press and hold the ▶ [REPEAT] button on the player or press and hold the REPEAT button on the remote to activate A-B repeat mode. REPEAT will blink at the top of**

6 – Various Playback Functions

the display.

- 2 Press the PITCH [MENU] knob on the player or the REPEAT button on the remote at the beginning of the interval that you want to repeat (A point). A-B will blink at the top of the display.
- 3 Once again, press the PITCH [MENU] knob on the player or the REPEAT button on the remote at the end of the interval that you want to repeat (B point).
Repeat playback between the A and B points will begin, and A-B will stop blinking and continue to appear at the top of the display.
- 4 To end A-B repeat playback, press the ■ (stop) [INTRO CHECK] button on the player or the ■ STOP button on the remote.

NOTE

- A-B repeat playback cannot be used with a data CD.
- Once playback reaches the B point, playback will restart from the A point.
- A-B repeat playback across more than one track is not possible.

Intro check mode

The Intro Check mode allows 10-second track beginnings to be played in succession. Use the following procedures to enable this mode.

Using the front panel buttons:

- 1 When stopped and in shift mode (SHIFT indicator lit), press the ■ (stop) [INTRO CHECK] button. INT appears on the right side of the display.

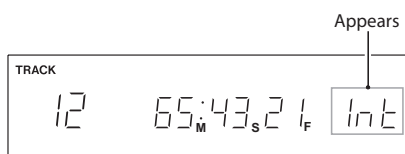

- 2 Disable shift mode (SHIFT indicator not lit) and press the ► (play) [REPEAT] button to activate the intro check mode starting from the next track.
- 3 Press the ■ (stop) [INTRO CHECK] button again to stop the play and disable intro check mode.

Using the remote control:

- 1 When stopped or paused, press the remote INTRO CHECK button to enable intro check mode. INT appears on the right side of the display.

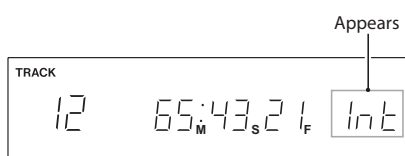

NOTE

If you press the INTRO CHECK button on the remote control during playback, INT appears on the right side of the display and intro check starts immediately.

- 2 If stopped or paused, press the ► PLAY button to start intro check.
- 3 Press the ■ STOP button to stop playback and disable intro check mode.
Press the INTRO CHECK button again to disable intro check mode and continue playback.

Power on play function

By using a commercially-available external timer, you can make the player turn on at desired times and start playback.

- 1 First, connect the power of this unit so that it receives power from the timer.
- 2 Load the disc that you want played back.
- 3 Set the 07 P onPL menu item to ON (default value: OFF).

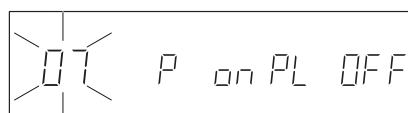

- 4 Leave the POWER switch of this unit set to ON, turn the power off from the timer and set the timer to turn on at the desired time. At the set time, the timer should supply power to the player, turning it on, and playback should begin automatically.

NOTE

The power on play function on/off setting is retained even when the power is turned off.

Pitch control playback

Using its pitch control playback function, this unit can vary the pitch (and speed) of playback.

Follow these procedures to use pitch control playback.

When this function is on, PITCH and the setting value appear in the PITCH display area on the right side of the display.

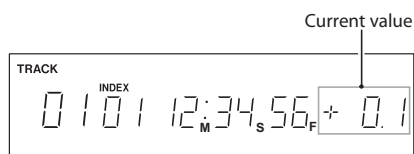

Using the front panel buttons:

Press the PITCH [MENU] knob to turn the pitch control function on. Turn the PITCH [MENU] knob to adjust the setting in the range between -16% and +16%.

Using the remote control:

Press the **PITCH** button to turn the pitch control function on. Use the **+** and **-** buttons to adjust the setting in the range between **-16%** and **+16%**.

Setting the pitch adjustment increment

To set the adjustment increment for pitch control playback (pitch step) use the **12 P-STEP** menu item.

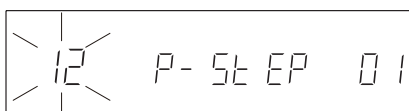

Options (%): 0.1 (default value), 0.5, 1.0

NOTE

The pitch step setting is retained even when the power is turned off.

Changing the playback speed without changing the pitch (KEY ORIG)

Ordinarily, when using the pitch control function, the speed changes along with the pitch. When the original key function is on, however, the pitch does not change even when the playback speed is changed.

Use one of the following procedures to turn the original key function on/off.

- Press the **KEY ORIG** button on the remote.
- Use the **01 Origin** menu item (default value: OFF).

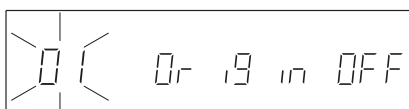

When the original key function is on, **KEY ORIG** appears at the bottom of the display.

NOTE

The original key function on/off setting is retained even when the power is turned off.

Program playback

By setting a program in advance, you can set the unit to play tracks in the order that you want. Up to 100 tracks can be added to the program. To use program playback to play tracks in the program order, set the playback mode to program playback mode and start playback. (See "Selecting the playback mode" on page 23.)

Program setting mode

Use the following procedures to enter program setting mode and add tracks to the empty program.

NOTE

- You can add tracks to the program regardless of the current playback mode.
- You can add the same track to the program multiple times.
- The program setting is retained even when the power is turned off or the disc is ejected. The player can remember one program for up to 100 discs.

Using the front panel buttons:

- 1 **When playback is stopped, select the 04 Prog menu item, and press the PITCH [MENU] knob to enter program setting mode. The display appears as follows.**

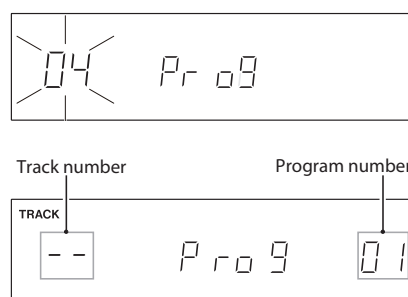

- 2 **Use the number buttons or SKIP [◀◀ / ▶▶] [INDEX/DIR SEARCH] buttons to select the number of the track that you want to add at the currently displayed program number. The selected track number blinks.**
- 3 **Turn the PITCH [MENU] knob to the right or press the SEARCH [▶▶] [A.READY] button to add the selected track. The next program number is shown.**
- 4 **Repeat steps 2 and 3 to add tracks as desired.**

NOTE

After selecting a track, turning the **PITCH [MENU]** knob to the right or pressing the **SEARCH [▶▶] [A.READY]** button adds the track to the program. If you exit program setting mode without doing this, the track selected just before will not be added to the program.

- 5 **When you are done adding tracks to the program, press the PITCH [MENU] knob to exit program setting mode.**

Using the remote control:

- 1 **When stopped, press the PGM button to enter program setting mode. The display appears as follows.**

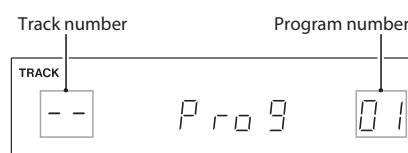

6 – Various Playback Functions

- 2 Use the number buttons or SKIP |◀◀/▶▶| buttons to select the number of the track that you want to add at the currently displayed program number. The selected track number blinks.
- 3 Press the SEARCH ▶▶ button to add the selected track. The next program number is shown.
- 4 Repeat steps 2 and 3 to add tracks as desired.

NOTE

After selecting a track, pressing the **SEARCH ▶▶** button adds the track to the program. If you exit program setting mode without doing this, the track selected just before will not be added to the program.

- 5 When you are done adding to the program, press the **PGM** button to exit the program setting mode.

Checking the program

When playback is stopped, follow step 1 of “Program setting mode” above to enter program setting mode and then follow the procedures below.

Using the front panel buttons:

Turn the **PITCH [MENU]** knob or press the **SEARCH ◀◀/▶▶ [A.CUE/A.READY]** buttons to select a program number to confirm the track that it contains. The track number is shown to the right of the program number.

Using the remote control:

Use the **SEARCH ◀◀/▶▶** buttons to select a program number to confirm the track that it contains. The track number is shown to the right of the program number.

Editing the program

You can change the contents of the program.

When playback is stopped, follow step 1 of “Program setting mode” above to enter program setting mode and then follow the procedures below.

■ Changing program tracks

Using the front panel buttons:

- 1 Turn the **PITCH [MENU]** knob or press the **SEARCH ◀◀/▶▶ [A.CUE/A.READY]** buttons to select the program number that you want to change.
- 2 Use the number buttons or SKIP |◀◀/▶▶| [**INDEX/DIR SEARCH**] buttons to select the desired track.
- 3 Turn the **PITCH [MENU]** knob to the right or press the **SEARCH ▶▶ [A.READY]** button to confirm the change.

Using the remote control:

- 1 Use the **SEARCH ◀◀/▶▶** buttons to select the program number that you want to change.
- 2 Use the number buttons or SKIP |◀◀/▶▶| buttons to select the desired track.
- 3 Press the **SEARCH ▶▶** button to confirm the change.

■ Inserting tracks into the program

Using the front panel buttons:

- 1 Turn the **PITCH [MENU]** knob or press the **SEARCH ◀◀/▶▶ [A.CUE/A.READY]** buttons to select the program number where you want to insert a track.
- 2 Press the **SEARCH ▶▶ [A.READY]** button while pressing and holding the **DISPLAY [LOCK]** button.
- 3 Use the number buttons or the SKIP |◀◀/▶▶| [**INDEX/DIR SEARCH**] buttons to select the track that you want to insert.
- 4 Turn the **PITCH [MENU]** knob to the right or press the **SEARCH ▶▶ [A.READY]** button to insert the track.

Using the remote control:

- 1 Use the **SEARCH ◀◀/▶▶** buttons to select the program number where you want to insert a track.
- 2 Press the **A.RDY/INS** button.
- 3 Use the number buttons or SKIP |◀◀/▶▶| buttons to select the track that you want to insert.
- 4 Press the **SEARCH ▶▶** button to insert the track.

■ Deleting tracks from the program

Using the front panel buttons:

- 1 Turn the **PITCH [MENU]** knob or press the **SEARCH ◀◀/▶▶ [A.CUE/A.READY]** button to select the program number of the track that you want to delete.
- 2 Press the **SEARCH ◀◀ [A.CUE]** button while pressing and holding the **DISPLAY [LOCK]** button to delete the track from the program.

Using the remote control:

- 1 Use the **SEARCH ◀◀/▶▶** buttons to select the program number of the track that you want to delete.
- 2 Press the **A.CUE/DEL** button to delete the track from the program.

■ After editing the program

Press the remote **PGM** button or the **PITCH [MENU]** knob on the player to exit program setting mode.

■ Removing all tracks from the program

Press and hold the **CLEAR [1-10/11-20]** button on the player or the remote **CLEAR** button to remove all tracks from the program.

Fade in/fade out playback

The player can be set to fade in at the beginning of playback and fade out when playback is stopped or paused. The fade in and fade out times, which determine how many seconds fading in and fading out takes, can be set independently. Use the **05 FADE** menu item to make fade in and fade out settings. The use of this menu

6 – Various Playback Functions

item differs slightly from the others. Use the following procedures with this item.

1 Select the 05 FADE menu item.



Press the PITCH [MENU] knob to enter fade in/out setting mode. The screen appears as follows.



2 Press the PITCH [MENU] knob or the remote ENTER button to enter fade in setting mode.

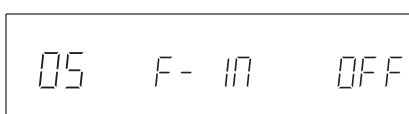

3 Turn the PITCH [MENU] knob on the player or use the PREV and NEXT buttons on the remote to set the fade in time. The fade in time can be set between 0.5 and 10 seconds in 0.5-second increments (default value: OFF).

4 Press the PITCH [MENU] knob on the player or the ENTER button on the remote to confirm the fade in setting and enter fade out setting mode.

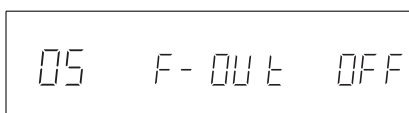

5 Turn the PITCH [MENU] knob on the player or use the PREV and NEXT buttons on the remote to set the fade out time. The fade out time can be set between 0.5 and 10 seconds in 0.5-second increments (default value: OFF).

6 Press the PITCH [MENU] knob on the player or the ENTER button on the remote to confirm the fade out setting and exit menu mode.

The display returns to its usual appearance.

NOTE

- FADE appears at the bottom of the display whenever fade in or fade out is set.
- To set only the fade out time, in fade in/out setting mode step 1 above, turn the PITCH [MENU] knob on the player (or press the PREV or NEXT button on the remote) until OUT blinks. Then, press the PITCH [MENU] knob on the player (or the ENTER button on the remote) to enter fade out setting mode.
- To set only the fade in time, after step 4 above, press the DISPLAY [LOCK] button on the player or the MENU button on the remote to exit menu mode.
- The fade in/out function settings are retained even when the power is turned off.

Skip back playback

During playback, you can skip back by a preset amount of time and continue playback.

During playback, press the ► (play) [REPEAT] button.

Setting the skip back time

To set the skip back time, use the 14 S-BAC menu item.

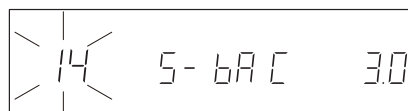

Options: 0–60 seconds (0.5-second increments, default value: 3 seconds)

NOTE

- When the incremental play function is on, it receives priority and skip back playback is disabled when you press the ► PLAY button on the remote. Use the ► (play) [REPEAT] button on the front panel or turn the incremental play function off.
- Skip back playback is only possible with audio CDs. Skip back playback is not possible with data CDs.
- Skip back playback settings are retained even when the power is turned off.

Flash start function

The beginnings of up to twenty tracks can be pre-loaded into memory, enabling their playback to be triggered instantly

When tracks have been added to the program, the beginnings of the first 20 tracks in the program will be loaded into memory.

When no tracks have been added to the program, the beginnings of the first 20 tracks on the disc will be loaded into memory.

NOTE

- The flash start function is only possible with audio CDs. The flash start function is not possible with data CDs.
- When playing back using the flash start function, the auto-cue and auto-ready functions are disabled.

Using the front panel buttons:

- 1 Prepare the program as necessary.
- 2 When in shift mode (SHIFT indicator lit), press the 1 [FLASH] number button.

NOTE

Setting the 19 FLASH menu item to ON has the same effect (default value: OFF).

6 – Various Playback Functions



- 3 While the beginnings of the tracks are being loaded into memory, the word **FLASH** blinks on the display. After loading completes, **FLASH 01-10** appears on the display and the ► **PLAY** indicator blinks.

- 4 Press the number button for the program number (when program set) or track number (when program not set) that you want to play.

To select numbers between 11 and 20, press the **CLEAR [1-10/11-20]** button, so that **FLASH 11-20** appears on the display, and then press the corresponding number button. Press the **CLEAR [1-10/11-20]** button again to return to **FLASH 1-10**.

Using the remote control:

- 1 Prepare the program as necessary.
- 2 Press the **FLASH** button.
- 3 While the beginnings of the tracks are being loaded into memory, the word **FLASH** blinks on the display. After loading completes, **FLASH 01-10** appears on the display and the ► **PLAY** indicator blinks.
- 4 Press the number button for the program number (when program set) or track number (when program not set) that you want to play.
To select numbers between 11 and 20, press the **CLEAR [1-10/11-20]** button, so that **FLASH 11-20** appears on the display, and then press the corresponding number button. Press the **CLEAR [1-10/11-20]** button again to return to **FLASH 1-10**.

■ Exiting flash start mode

Using the front panel buttons:

When in shift mode (**SHIFT** indicator lit), press the **1 [FLASH]** number button to exit flash start mode.

Using the remote control:

Press the **FLASH** button to exit flash start mode.

Relay playback

Multiple CD-500 and CD-500B units can be used together and set so that when playback ends on one unit, playback can automatically start on another unit.

To do this, connect the **CONTROL I/O START (RELAY IN)** connector on the rear panel of the CD-500/CD-500B to the **CONTROL I/O DISC EOM (RELAY OUT)** on another CD-500/CD-500B with a cable and enable relay playback mode on both units.

To enable relay playback mode, set the **06 RELAY** menu item to **ON**.



By connecting two CD-500/CD-500B units in both directions as shown in illustration below, alternating playback between them is possible.

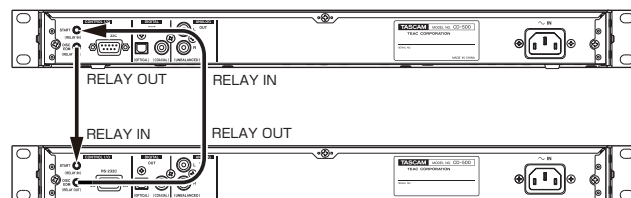

By connecting three or more CD-500/CD-500B units in sequence (**CONTROL I/O START (RELAY IN)** to **CONTROL I/O DISC EOM (RELAY OUT)**) as shown below, automatic playback of one unit after the other is possible.

NOTE

The relay playback function on/off setting is retained even when the power is turned off.

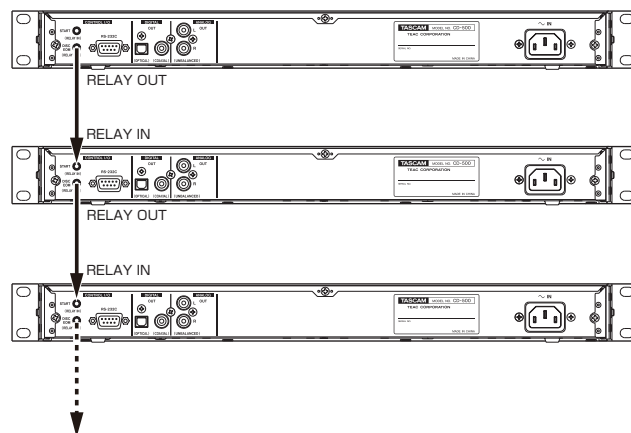

Changing the playback time display mode

You can select the playback time that is shown on the display.

During playback or when paused, press the **DISPLAY [LOCK]** button on the player or the **DISPLAY** button on the remote. Each press of the button cycles through the three types of time display. The currently selected display mode is shown in the playback time mode display area.

- **T.REMAIN:** total remaining time is displayed
- **REMAIN:** remaining time of the current track is displayed
- **Nothing:** elapsed time of the current track is displayed

NOTE

- When an audio CD is stopped, the total recording time is always shown regardless of whether or not **T.REMAIN** or **REMAIN** appears.
- For data CDs, neither the total time when stopped, nor the remaining time or total remaining time during playback are shown. (Only the number of tracks or track number appears.)
- In program playback mode, remaining time shows the time until playback of the program ends. In single playback mode, remaining time shows the remaining time in the track.
- In program playback mode, the total time shown is for the program.
- The playback time display mode setting is retained even when the power is turned off.

Frame time display setting

You can set whether or not the frame time is shown during playback. To set the frame time display, use the **17 FRAM** menu item (default value: ON).

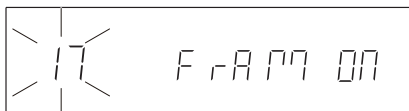

NOTE

The frame time display on/off setting is retained even when the power is turned off.

End of track warning (EOM)

During audio CD playback, a warning indication can be shown on the display when nearing the end of a track. The end of track warning function does not work with data CDs.

By setting in advance the number of seconds before the track end that the warning is shown, when playback

reaches that point, the “#” in the time display will begin blinking.



Use the **10 EOM** menu item to set the value from among the following options.



Options: OFF, 5, 10, 15, 20, 25, 30 (default value), 35

For values other than OFF, the number indicates the number of seconds before the end of the track that the warning begins. At the default value, the “#” begins to blink 30 seconds before the end of the track.

NOTE

The EOM function setting is retained even when the power is turned off.

Interval time setting

The player can be set to wait for a specified time (interval time) after completing playback of one track before starting playback of the next track.

To make the interval time setting, use the **16 INTVAL** menu item.

- 1 **Select the 16INTVAL menu item.**

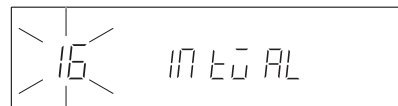

- 2 **Press the PITCH [MENU] knob to enter interval time setting mode. The screen appears as follows.**

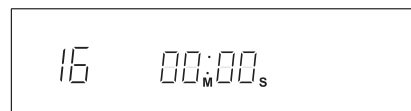

- 3 **Turn the PITCH [MENU] knob to set the interval time, and press the PITCH [MENU] knob to confirm the setting.**

Setting range: 0–5 minutes (10-second increments, default value: 0 seconds)

NOTE

The interval time setting is retained even when the power is turned off.

7 – Other Functions

Outputting in mono

This player can output analog and digital signals in mono. To make the player output in mono, set the 08 Mono menu item to ON (default value: OFF).

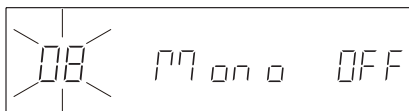

When mono output is on, MONO appears at the bottom of the display.

NOTE

The mono output on/off setting is retained even when the power is turned off.

Controlling the player with a foot switch

You can connect a TASCAM RC-3F foot switch (sold separately) to the **REMOTE** jack on the front panel and use it to control the player.

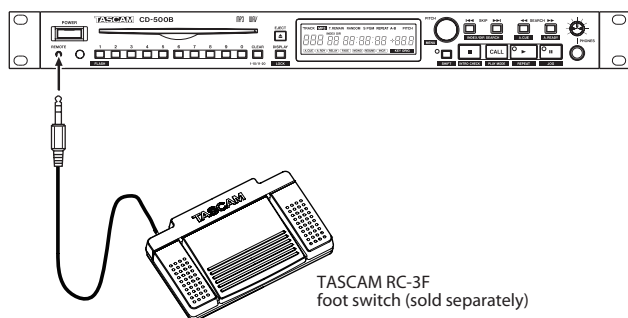

TASCAM RC-3F foot switch (sold separately)

Setting the foot switch

To set the foot switch, use the 18 REMOT menu item to assign the functions to the switch controls (pedals).

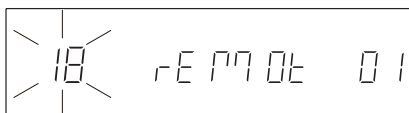

Options: OFF, 1 (default value), 2, 3, 4

Using the foot switch

When you press the controls (pedals) on the foot switch, they function according to the 18 REMOT setting.

Foot switch mode settings

The functions of the controls in each mode are as follows.

MODE	Footswitch controls		
	L (brief press)	C (brief press)	R (brief press)
	L (long press)	C (long press)	R (long press)
1	⏪	PLAY/PAUSE	⏩
	⏮	STOP	⏭
2	SKIP BACK	PLAY/PAUSE	CALL
	⏮	STOP	⏭
3	PITCH (-)	PLAY/PAUSE	PITCH (+)
	PITCH (-) continuous	STOP	PITCH (+) continuous
4	PAUSE	PLAY	STOP
	---	---	---

Fader and event start

Fader start and stop

By connecting an external fader switch, the player can be started and stopped using a fader

■ Using the CONTROL I/O START (RELAY IN) connector

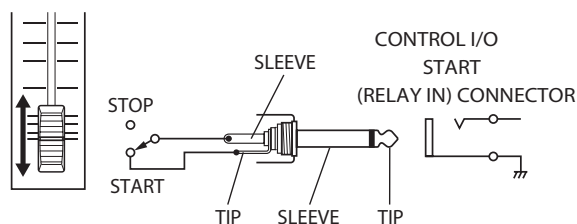

Use a fader switch and 3.5-mm miniplug wired as shown above. Connect the miniplug to the **CONTROL I/O START (RELAY IN)** connector on the rear panel of the unit. Then, set the 06 RELAY menu item to FDR.



■ Using the CONTROL I/O PARALLEL connector [CD-500B only]

Connect the fader switch and the CD-500B **CONTROL I/O PARALLEL** connector as shown below.

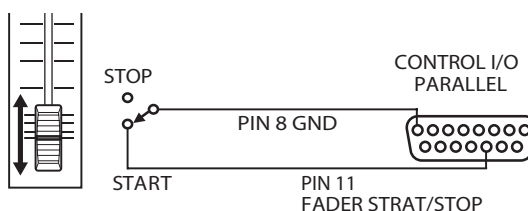

For details about using the **CONTROL I/O PARALLEL** connector, see “Using the parallel connector (CD-500B only)” on page 33.

Event start

■ Using the CONTROL I/O START (RELAY IN) connector

Wire the event output connector of another device with a 3.5-mm miniplug, and connect that 3.5-mm miniplug to the **CONTROL I/O START (RELAY IN)** connector on the rear panel of this unit.

Then, set the 06 RELAY menu item to ON.



■ Using the CONTROL I/O PARALLEL connector [CD-500B only]

With the CD-500B, when stopped or paused, playback can be started by inputting a one-shot pulse signal from outside. Input a one-shot pulse (active low, 30 ms or longer) through pin 13 of the **CONTROL I/O PARALLEL** connector.

Using the RS-232C connector

The **CONTROL I/O RS-232C** connector (D-sub 9-pin, RS-232C compliant) can be used for serial control of this unit by a computer or other external device.

Setting the baud rate

Use the 13 232C menu item to set the baud rate.

Select 96 (9600 bps, default value), 192 (19200 bps) or 384 (38400 bps).

For further details, please contact TASCAM customer support.

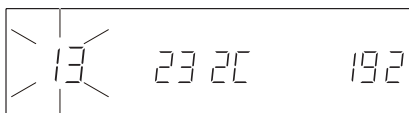

NOTE

The baud rate setting is retained even when the power is turned off.

Restoring factory default settings

You can restore the unit to factory default settings that are stored in the backup memory. The following default settings are stored in the backup memory

- Playback mode
- Playback time display mode

- Auto-ready function on/off
- Auto-cue function on/off
- Repeat function on/off
- Various menu settings (original key, eject block, auto-cue level, program, fade in/out, relay playback, power on play, mono output, resume, EOM time, incremental playback, pitch step, RS232C baud rate, skip back, remote control receipt, interval time, frame display, foot switch, user data, parallel mode)

To restore all settings to their factory defaults

- 1 Select the 20 RESET menu item.

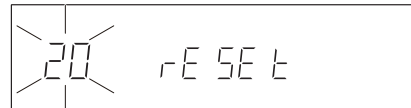

- 2 Press the PITCH [MENU] knob.

–SURE– blinks on the display.

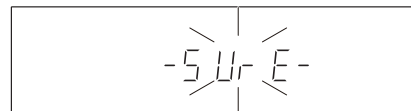

- 3 Press the PITCH [MENU] knob on the main unit or the ENTER button on the remote control to restore the settings to the factory defaults stored in the backup memory and exit menu mode.

The display returns to ordinary disc and track information.

Checking the firmware version

To check the firmware version, use the 21 INFO menu item.

- 1 Select the 21 INFO menu item.



- 2 Press the PITCH [MENU] knob on the main unit or the ENTER button on the remote control to show the system firmware version on the display.

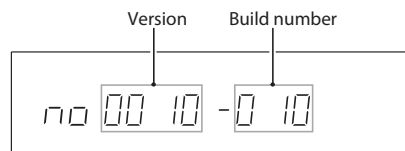

- 3 Press the PITCH [MENU] knob on the main unit or the ENTER button on the remote control again to return to menu item selection.

7 – Other Functions

User data settings (CD-500B only)

You can set whether or not a USER DATA BIT is output with the digital output from the **DIGITAL OUT (AES/EBU)** connector. To set output of the USER DATA BIT, use the 22 U-DATA menu item (default value: ON).

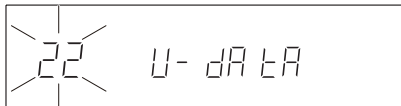

NOTE

- If the signal output from this connector does not play back correctly, set this item to OFF.
- The user data setting is retained even when the power is turned off.

Using the parallel control (CD-500B only)

Using the **CONTROL I/O PARALLEL** connector, you can use external parallel control to operate this unit. Two types of parallel control (normal mode and direct play mode) can be used with this unit. To set parallel control, use the 23 PARALL menu item.

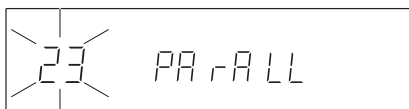

Options:

1 Normal mode (default)

In addition to starting, stopping and skipping, fader start/stop are controlled.

2 Direct play mode

Tracks 1–20 can be played directly.

The pin assignments are as follows

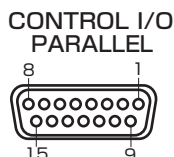

Pin No.	Function		IN/OUT
	MODE: 1	MODE: 2	
1	STOP Tally	←	OUT
2	SKIP (Back)	Select: 1	IN
3	SKIP (Forward)	Select: 2	IN
4	NO DISC Tally	←	OUT
5	EOM	←	OUT
6	SEARCH (Back)	Track Play: 1*	IN
7	SEARCH (Forward)	Track Play: 2*	IN
8	GND	←	

9	PLAY Tally	←	OUT
10	PAUSE Tally	FLASH LOAD Tally***	OUT
11	FADER START / STOP	Track Play: 3*	IN
12	STOP	STOP / FLASH LOAD**	IN
13	PLAY	Track Play: 4*	IN
14	PAUSE	Track Play: 5*	IN
15	+5V	←	

IN: active low external command reception (operates when ground 30 ms or longer)

OUT: signal for the display of transport status by open collector (maximum voltage 15 V, maximum current 50 mA)

+5V: maximum supplied current 50 mA

* Track Play 1–5: plays the designated track. The track played depends on the combination of Select: 1 (Pin 2) and Select: 2 (Pin 3) High (1) and Low (0) settings as shown below.

** When stopped and the flash start function is on, if the track beginnings have not yet been loaded, loading starts. When playing back, playback stops.

*** When the flash start function is on, if the track beginnings have been loaded completely, High (1) results. If the track beginnings have not yet been loaded, or are in the process of loading, Low (0) results.

Pin No.	Mode 2 function	Select 1 and 2 combination			
		0	0	1	1
2	Select: 1	0	0	1	1
3	Select: 2	0	1	0	1
6	Track Play: 1	Track 1	Track 6	Track 11	Track 16
7	Track Play: 2	Track 2	Track 7	Track 12	Track 17
11	Track Play: 3	Track 3	Track 8	Track 13	Track 18
13	Track Play: 4	Track 4	Track 9	Track 14	Track 19
14	Track Play: 5	Track 5	Track 10	Track 15	Track 20

NOTE

The parallel mode setting is retained even when the power is turned off.

Please check the following items if the unit is not functioning properly. If you are still unable to resolve the problem please contact the retailer where you purchased the unit or TASCAM customer support.

■ **Power does not turn on**

Make sure that the power plug is firmly inserted.

■ **Unit cannot be controlled from the front panel**

Make sure that the panel lock function is not on.

■ **Unit cannot be controlled with the remote control.**

Confirm that batteries are in the remote control and that they have a charge.

■ **No sound**

Confirm the unit's connections to the monitoring system and check the volume of the amplifier.

■ **CD cannot be played back**

- If it is a data CD, containing MP3 files, confirm that they use a bit rate that this unit can handle.
- Confirm that the disc is not scratched or dirty.

■ **Noise is heard**

Check whether a connection cable might have a bad connection.

9 – Error Messages

When one of the following error messages appears, refer to the response below and resolve the cause. If you are still unable to resolve the problem please contact TASCAM customer support.

Message	Meaning	Response
Err01	TOC Read Error	Clean or change the disc.
Err09	Flash ROM Error	If one of these errors appears, turn the power off and back on. If you are unable to turn the power off, disconnect the power cord.
Err10	SDRAM Error	
Err13	SYSTEM Error	

Media and formats

Device type

CD player

Compatible discs

Compact discs (12-cm only)

Playable disc types

CD, CD-R, CD-RW

Playable disc and file formats

Audio CD (CD-DA), MP3, WAV

Number of channels

2

Quantization rate

16-bit

Sampling frequencies

32 kHz, 44.1 kHz, 48 kHz

Analog audio output

Analog out connectors (unbalanced)

Connector: RCA pin jacks

Output impedance: 1 k Ω or less

Standard output level: -10 dBV (0.32 Vrms)

Maximum output level: +6 dBV (2.0 Vrms)

Analog out connectors (balanced, CD-500B only)

Connector: XLR-3-32 (1: GND, 2: HOT, 3: COLD)

Output impedance: 150 Ω

Standard Output level: +4 dBu (1.23 Vrms)

Maximum Output level: +20 dBu (7.75 Vrms)

PHONES connector

Connector: 6.3-mm (1/4") standard stereo jack

Maximum output level: 45 mW + 45 mW or more
(THD+N 0.1% or less, 32 Ω load)

Digital audio output

Digital out connector (optical)

Connector: optical

Supported signal format: IEC-60958-3 standard for consumers (S/PDIF)

Digital out connector (coaxial)

Connector: RCA-pin jack

Supported signal format: IEC-60958-3 standard for consumers (S/PDIF)

Output impedance: 75 Ω

Output level: 0.5 Vp-p

Digital out connector (AES/EBU, CD-500B only)

Connector: XLR-3-32 (1: GND, 2: HOT, 3: COLD)

Supported signal format: IEC60958-4 (AES/EBU)

Output impedance: 110 Ω

Control input and output

REMOTE connector

Connector: 2.5-mm TRS jack

CONTROL I/O START (RELAY IN) connector

Connector: 3.5-mm TS jack

CONTROL I/O DISC EOM (RELAY OUT) connector

Connector: 3.5-mm TS jack

RS-232C connector

Connector: D-sub 9-pin

CONTROL I/O PARALLEL connector (CD-500B only)

Connector: D-sub 15-pin

Audio performance

Frequency response

20 Hz–20 kHz: \pm 0.5 dB (JEITA)

S/N ratio

95 dB or more (JEITA)

Dynamic range

95 dB or more (JEITA)

Distortion

0.005% or less (JEITA)

Channel separation

95 dB or more (1 kHz, JEITA)

Backup memory

The following settings are backed up even when the power is turned off.

- Playback mode
- Playback time display mode
- Auto-ready function on/off
- Auto-cue function on/off
- Repeat function on/off
- Various menu settings (original key, eject block, auto-cue level, program, fade in/out, relay playback, power on play, mono output, resume, EOM time, incremental playback, pitch step, RS232C baud rate, skip back, remote control receipt, interval time, frame display, foot switch, user data, parallel mode)

10 – Specifications

General

Power supply

AC 100-240 V, 50-60 Hz

Power consumption

11 W (CD-500), 12 W (CD-500B)

Dimensions (W x H x D)

482.6 x 44.9 x 300.5 mm

Weight

3.5 kg (CD-500), 3.7 kg (CD-500B)

Operating temperature range

5°–40° C

Installation tilt

Within 30°

Dimensional drawings

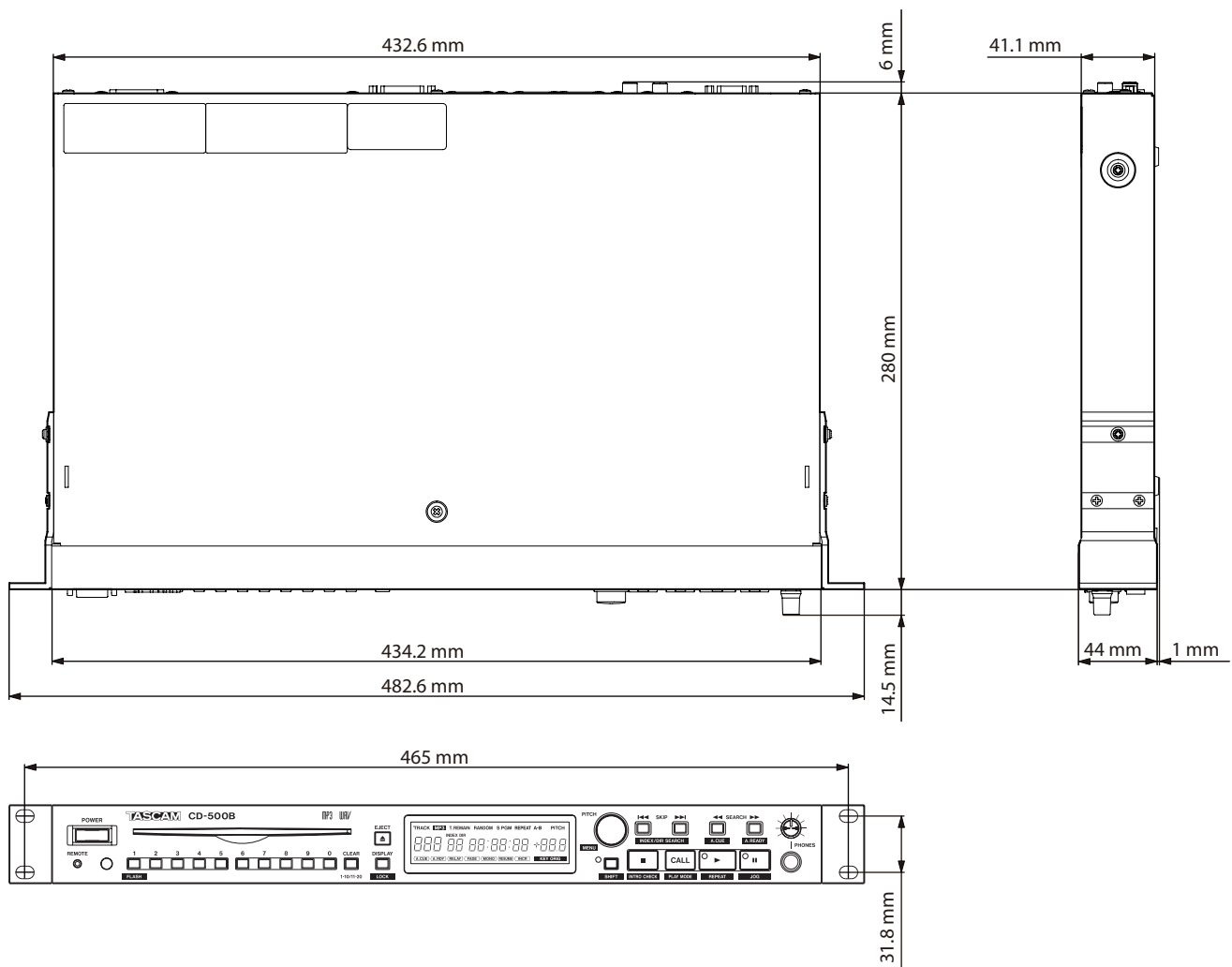

- Illustrations in this manual might differ from the actual product.
- In order to improve the product, specifications and appearance could be changed without prior notice.

WARRANTY

< In the United States >

This warranty gives you specific legal rights and you may also have other rights which vary from state to state. This warranty is only valid within the country the unit was originally purchased.

WHAT IS AND IS NOT COVERED

Except as specified below, this warranty covers all defects in materials and workmanship in this product. The following are not covered by the warranty:

1. **Damage to or deterioration of the external cabinet.**
2. **Damages resulting from accident, misuse, abuse or neglect.**
3. **Damage resulting from failure to perform basic daily maintenance and/or calibration or otherwise resulting from failure to follow instructions contained in your owner's manual.**
4. **Damage occurring during shipment of the product. (Claims must be presented to the carrier)**
5. **Damage resulting from repair or attempted repair by anyone other than TEAC or an authorized TASCAM service station.**
6. **Damage resulting from causes other than product defects, including lack of technical skill, competence, or experience of the user.**
7. **Damage to any unit which has been altered or on which the serial number has been defaced, modified or is missing.**

WHO MAY ENFORCE THE WARRANTY

This warranty may be enforced only by the original purchaser.

LENGTH OF WARRANTY

All parts except heads and disk drives are warranted for one (1) year from the date of original purchase. Heads and disk drives are warranted to ninety (90) days from date of original purchase. Labor is warranted for ninety (90) days from date of original purchase.

WHAT WE WILL PAY FOR

We will pay all labor and material expenses for items covered by the warranty. Payment of shipping charges is discussed in the next section of this warranty.

HOW YOU CAN GET WARRANTY SERVICE

Your unit must be serviced by an authorized TASCAM service station in the United States. (This warranty is not enforceable outside the U.S.) If you are unable to locate an authorized TASCAM service station in your area, please contact us. We either will refer you to an authorized service station or instruct you to return the unit to the factory. Whenever warranty service is required, you must present a copy of the original dated sales receipt from an Authorized TASCAM Dealer.

You must pay any shipping charges if it is necessary to ship the product to service. However, if the necessary repairs are covered by the warranty, we will pay return surface shipping charges to any destination within the United States.

LIMITATION OF IMPLIED WARRANTIES

Any implied warranties, INCLUDING WARRANTIES OF MERCHANTABILITY AND FITNESS FOR A PARTICULAR PURPOSE, are limited in duration to the length of this warranty.

EXCLUSION OF DAMAGES

TEAC's liability for any defective product is limited to repair or replacement of the product, at TEAC's option. TEAC shall not be liable for:

1. **Damages based upon inconvenience, loss of use of the product, loss of time interrupted operation or commercial loss; or**
2. **Any other damages, whether incidental, consequential or otherwise.**

Some states do not allow limitations on how long an implied warranty lasts and/or do not allow the exclusion or limitation of incidental or consequential damages, so the above limitations and exclusions may not apply to you.

To locate an Authorized Service Center in Your Area

CALL 1-800-447-8322

< Europe >

This product is subject to the legal warranty regulations of the country of purchase. In case of a defect or a problem, please contact the dealer where you bought the product.

Ce produit est sujet aux réglementations concernant la garantie légale dans le pays d'achat. En cas de défaut ou de problème, veuillez contacter le revendeur chez qui vous avez acheté le produit.

Dieses Gerät unterliegt den gesetzlichen Gewährleistungsbestimmungen des Landes, in dem es erworben wurde. Bitte wenden Sie sich im Gewährleistungsfall an den Händler, bei dem sie das Gerät erworben haben.

Questo apparecchio è conforme alle norme sulla garanzia vigenti nel rispettivo Paese in cui esso è stato acquistato. Si prega di rivolgersi al proprio commerciante, presso il quale è stato acquistato l'apparecchio, nel caso in cui si voglia richiedere una prestazione in garanzia.

Las condiciones de garantía de este aparato están sujetas a las disposiciones legales sobre garantía del país en el que ha sido adquirido. En caso de garantía, debe dirigirse al establecimiento donde adquirió el aparato.

< In other countries/areas >

This warranty gives you specific legal rights, and you may also have other rights that vary by country, state or province.

If you have a warranty claim or request, please contact the dealer where you bought the product.

该保证书赋予了顾客特定的合法权利，并且因国家、州或省等地域的不同，顾客可能拥有其他权利。如需申请或要求保修，请与购买本产品的销售店进行联系。

If you require repair services for your TASCAM equipment, please contact the dealer where the product was purchased from or the TASCAM Distributor in your country. A list of TASCAM Distributors can be found on our website at: <http://teac-global.com/>

TASCAM

TEAC CORPORATION

Phone: +81-42-356-9143

1-47 Ochiai, Tama-shi, Tokyo 206-8530 Japan

<http://tascam.jp/>

TEAC AMERICA, INC.

Phone: +1-323-726-0303

1834 Gage Road, Montebello, California 90640 USA

<http://tascam.com/>

TEAC MEXICO, S.A. de C.V.

Phone: +52-55-5010-6000

Río Churubusco 364, Colonia Del Carmen, Delegación Coyoacán, CP 04100, México DF, México

<http://teacmexico.net/>

TEAC UK LIMITED

Phone: +44-8451-302511

Meridien House, Ground Floor, 69 - 71, Clarendon Road, Watford, Hertfordshire, WD17 1DS, UK

<http://tascam.eu/>

TEAC EUROPE GmbH

Phone: +49-611-71580

Bahnstrasse 12, 65205 Wiesbaden-Erbenheim, Germany

<http://tascam.eu/>

TEAC SALES & TRADING(SHENZHEN) CO., LTD

Phone: +86-755-88311561~2

Room 817, Block A, Hailrun Complex, 6021 Shennan Blvd., Futian District, Shenzhen 518040, China

<http://tascam.cn/>

Printed in China

WARRANTY

Model/Modèle/Modell
Model/Modèle/Modell

CD-500/CD-500B

Serial No./No. de Série/Seriennummer
Numero di serie/Número de serie/序列号

Date of purchase/Date de l'achat/Datum des Kaufs
Data dell'acquisto/Fecha de compra/购买日期

TASCAM
<http://teac-global.com/>

Owner's name/Nom du possesseur/Name des Eigentümers
Nome del proprietario/Nombre del propietario/顾客姓名

Address/Adresse/Adresse
Indirizzo/Dirección/顾客地址

Dealer's name/Nom du détaillant/Name des Händlers
Nome del commerciante/Nombre del establecimiento/销售店名

Dealer's address/Adresse du détaillant/Adresse des Händlers
Indirizzo del commerciante/Dirección del establecimiento/销售店地址